

Course "Softwaretechnik"

Book Chapter 2

Modeling with UML

Lutz Prechelt, Bernd Bruegge, Allen H. Dutoit
Freie Universität Berlin, Institut für Informatik
<http://www.inf.fu-berlin.de/inst/ag-se/>

- Modeling, models and UML
- Static view:
 - Class diagrams
- Dynamic view:
 - Sequence diagrams
 - Statechart diagrams
 - Activity diagrams
- Other UML diagram types
 - component d., collaboration d., deployment d., communication d., interaction overview d.
- UML Metamodel, Profiles
- Some notation details
 - Classes, associations, interfaces, states

What is modeling?

- Modeling consists of building an abstraction of reality
 - Models ignore irrelevant details (i.e., they simplify)
 - and only represent the relevant details
- What is *relevant* or *irrelevant* depends on the purpose of the model. We typically want to
 - draw complicated conclusions about reality with simple steps in the model in order to
 - get insights into the past or present or make predictions
- Reality R:
 - Real things, people, etc.
 - Processes happening during some time
 - Relationships between things etc.
- Model M:
 - Abstractions of any or all of the above

What is a "good" model?

- In a good model, relationships which are valid in reality R are also valid in model M.
 - I : Mapping of reality R to the model M (abstraction)
 - f_M : relationship between abstractions in M
 - f_R : equivalent relationship between real things in R
- In a good model the following diagram is commutative:

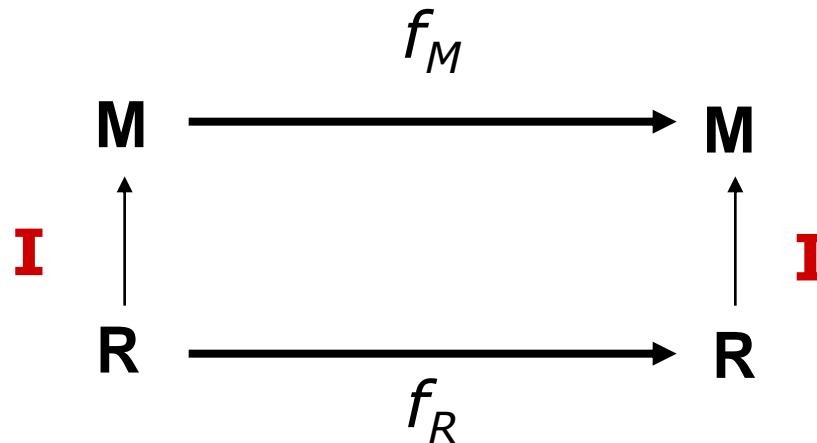

Models of models of models...

- Modeling is relative
- **We can think of a model as reality and can build another model from it (with additional abstractions)**
 - The development of software systems is a transformation of models:
Analysis,
Design,
Implementation

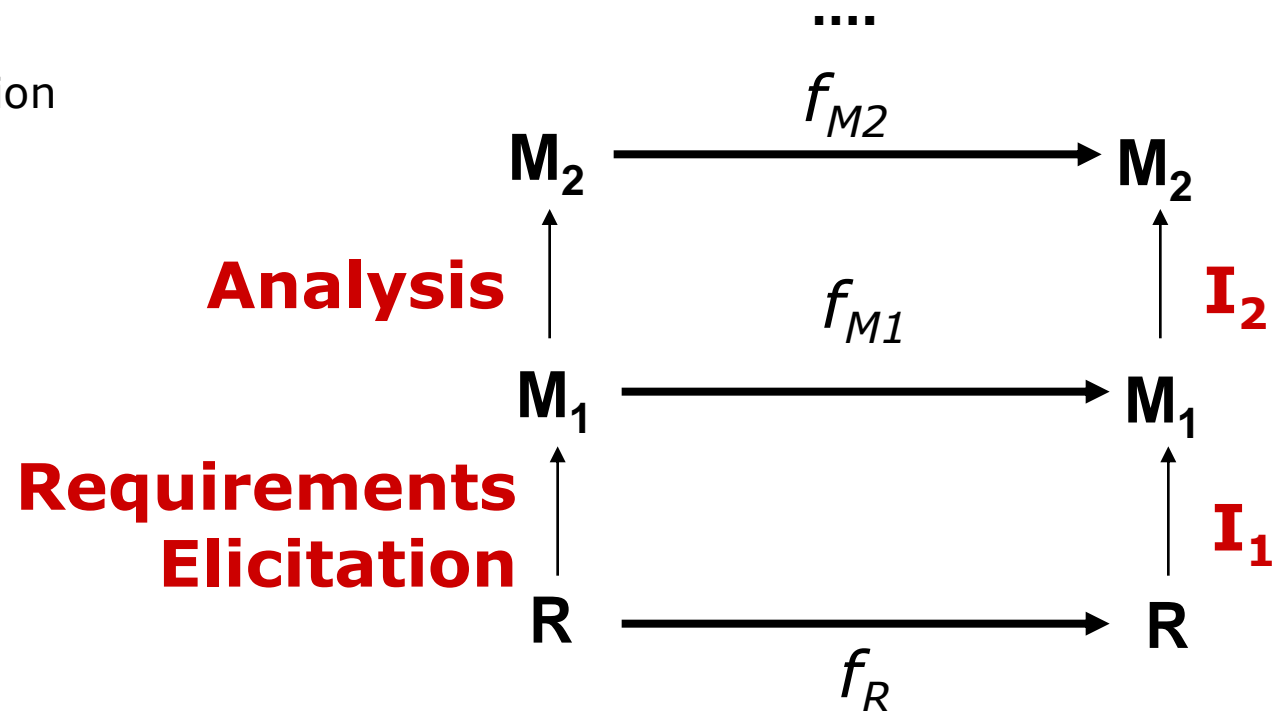

- A **model** is an abstraction describing relevant aspects of a system
- A **view** ("Sicht") depicts selected aspects of a model
 - Any view is a model itself
 - Calling a model a view makes clear it is part of a larger model
 - Complex models are often shown as many views only
 - never as a whole
- A **notation** is a set of rules for depicting models
 - graphically or textually
- Example:
 - System: Aircraft
 - Models: Flight simulator, scale model, construction plan, ...
 - Views: All blueprints (e.g. electrical wiring, fuel system)

What is UML?

UML (Unified Modeling Language):

- The de-facto standard for software modeling
 - For both requirements modeling (application domain)
 - and software modeling (solution domain)
- A set of related notations
 - Quite complex, we will use a subset only
- Resulted from the convergence of notations from three leading object-oriented methods:
 - OMT (James Rumbaugh)
 - OOSE (Ivar Jacobson)
 - Booch (Grady Booch)
 - The authors are known as "The Three Amigos"
- Supported by CASE tools
 - <http://de.wikipedia.org/wiki/UML-Werkzeug>



- Use Case diagrams (functional view)
 - Catalog scenarios that describe the functional behavior of the system as seen by the user [see lecture "use cases"]
- Class diagrams (static view)
 - Describe the static structure of the system: Classes, attributes, object associations
- Sequence diagrams (dynamic view)
 - Describe *examples* of the dynamic behavior between objects of the system (and possibly actors)
- Statechart diagrams (dynamic view)
 - Describe some aspects of the dynamic behavior of the individual object of a class by a finite state automaton
- Activity diagrams (dynamic view)
 - Model the dynamic behavior of a system, in particular the workflow (essentially a flowchart, but with concurrency)

Less common UML diagram types

Hardly covered in this course:

- Implementation diagrams
 - Component diagrams
 - Deployment diagrams
- Communication diagrams
 - Equivalent to sequence diagrams, but embedded in an object diagram (shows both static structure and dynamic interaction)
- Interaction overview diagrams
 - Related to activity diagrams, for describing control flow

There is also a non-graphical language for expressing conditions:

- Object constraint language (OCL)
 - Introduced in lecture on Object Design

UML core conventions

- Diagrams are mostly graphs
 - Nodes are entities
 - Edges are relationships between entities
- Rectangles are classes or instances
- Ovals are functions or use cases
- An instance is denoted with an underlined name
 - myWatch:SimpleWatch or with no type: myWatch
 - Joe:Firefighter or with no name: :Firefighter
- A type is denoted with a non-underlined name
 - SimpleWatch
 - Firefighter

UML class diagrams

Class diagrams represent the structure of the system

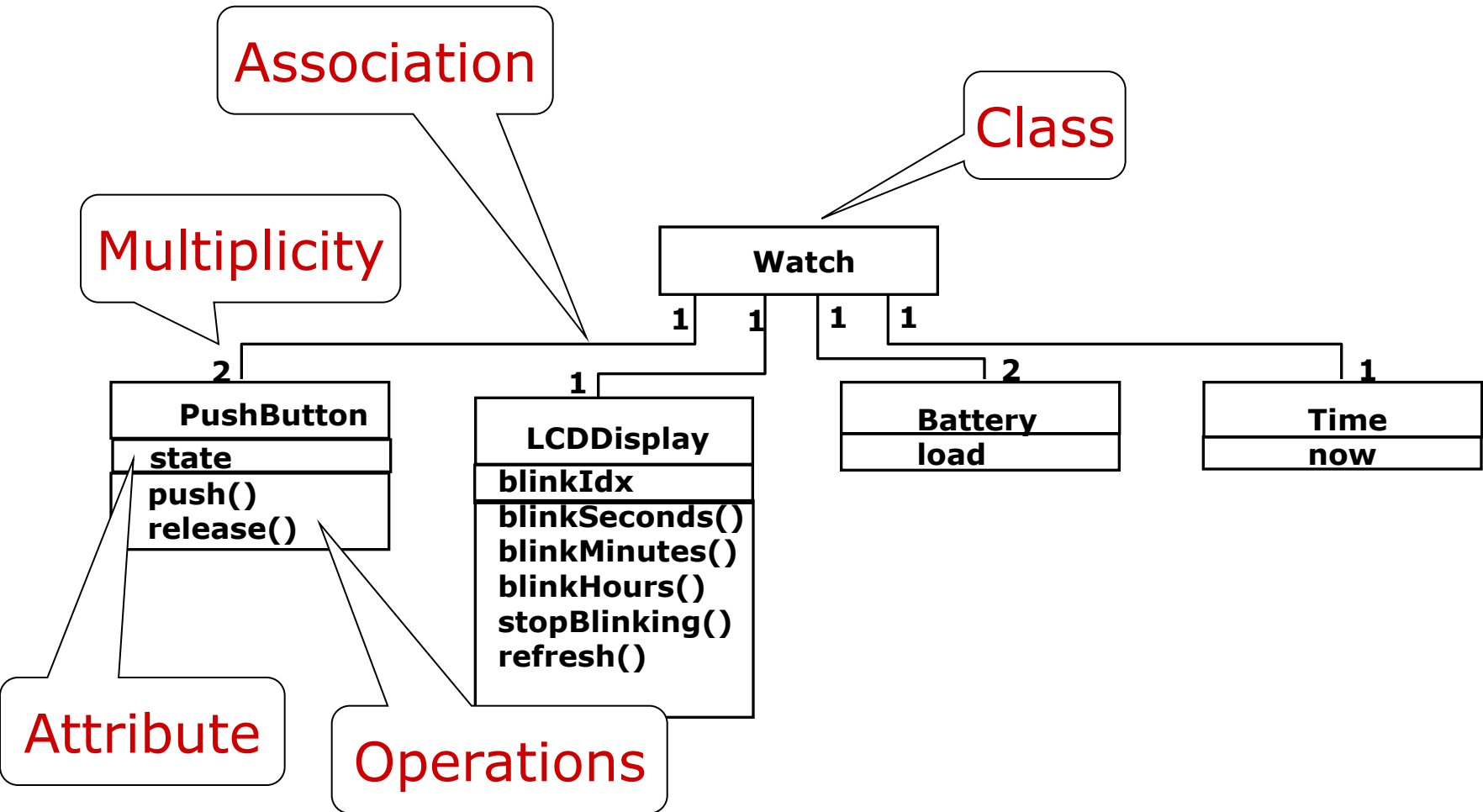

Class diagrams: Classes

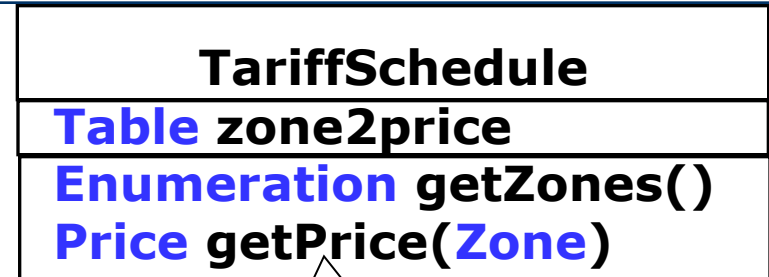
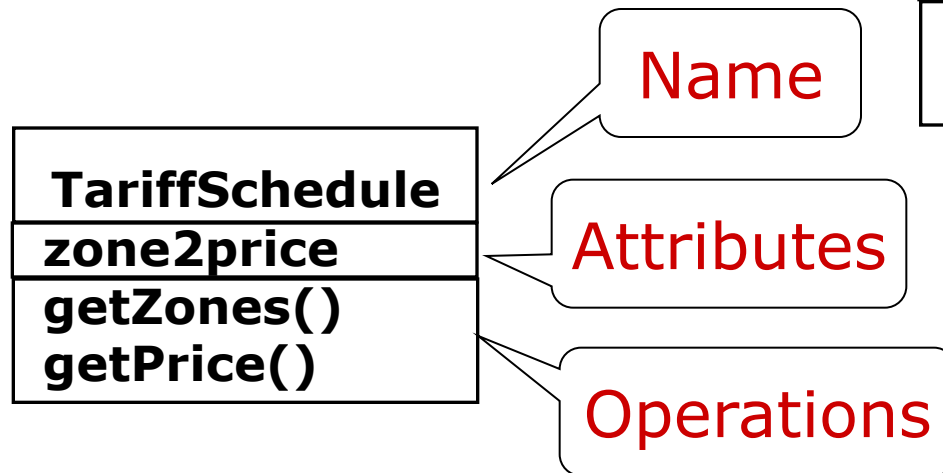

- A class represents a concept
- A class encapsulates state (attributes) and behavior (operations)
- Each attribute has a type
- Each operation has a signature
- But the class name is the only mandatory information in a UML class description

tariff1974:TariffSchedule

```
zone2price = {  
  {'1', .20},  
  {'2', .40},  
  {'3', .60}}
```

- An instance represents a phenomenon
- The name of an instance is underlined and may indicate the class of the instance
 - May indicate instance name or class or both
- Attributes may be represented with their values

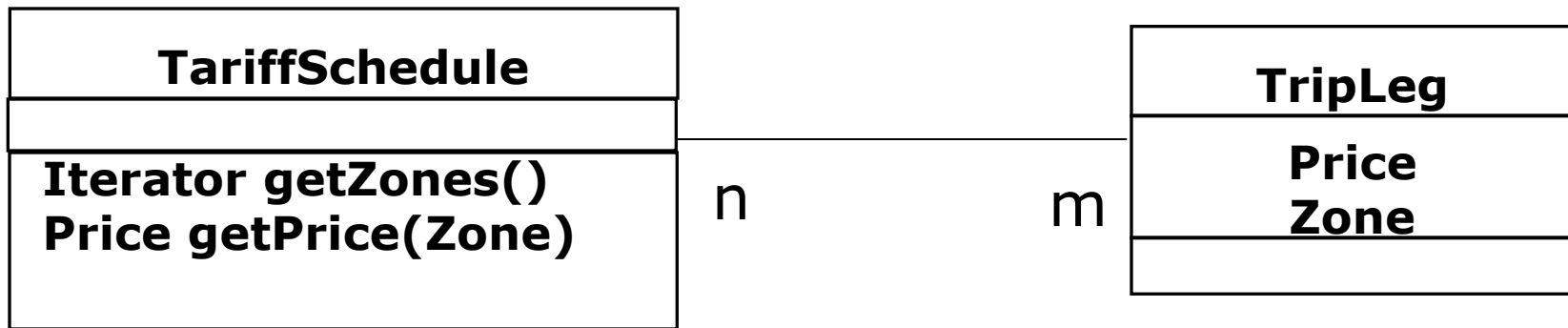

- Associations denote relationships between classes
- The multiplicity of an association end denotes how many objects the source object can legitimately reference:
 - Any one TariffSchedule object is associated with **m** TripLeg objects
 - Any one TripLeg object is associated with **n** TariffSchedule objects
 - **n** and **m** can be numbers ("5") or ranges ("1..5")
 - A missing annotation means 1
 - Informally, if there are no annotations anywhere, it may also mean *
 - * means "arbitrarily many" (zero, one, or several)

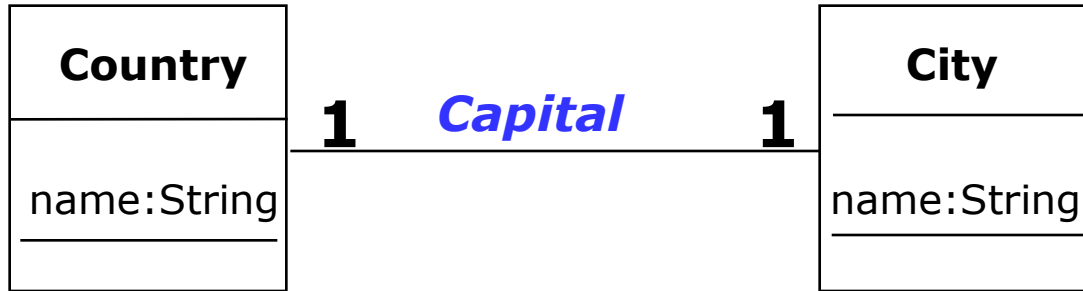

Too restrictive?:
Some countries
have a separate
seat of
government

One-to-one association



Too flexible?:
Does a Polygon
with 0, 1, or 2
Points really
make sense?

One-to-many association

Many-to-many associations

Problem Statement: "A stock exchange lists many companies. Each company is uniquely identified by a ticker symbol."

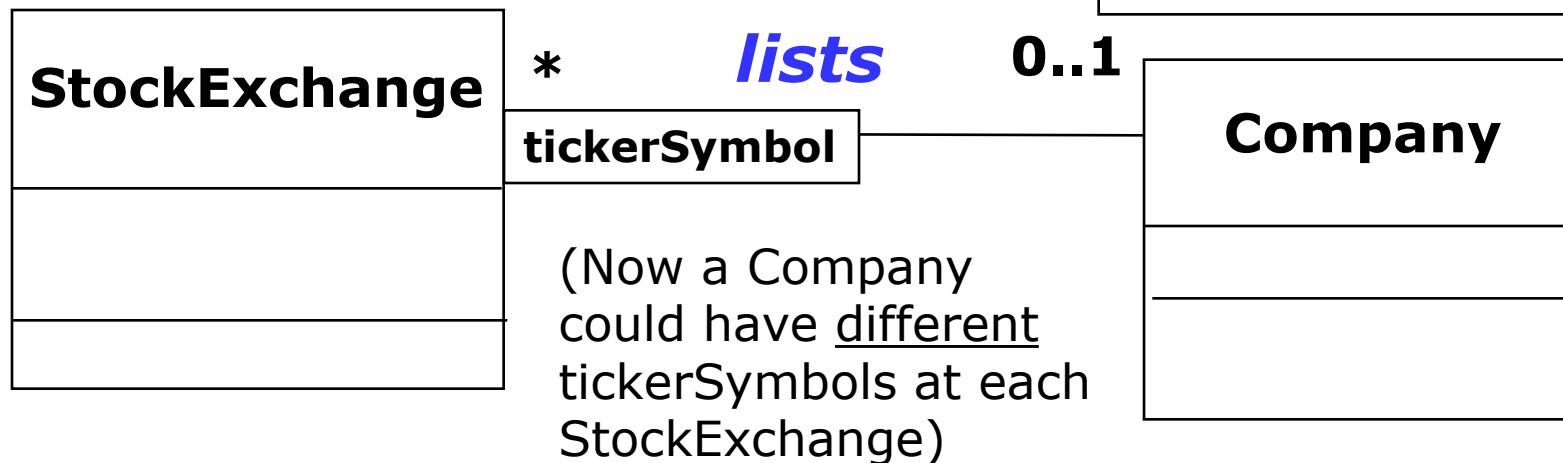

- An **aggregation** is a special case of association denoting a "consists of"/"is part of" hierarchy
- The object representing the whole is called the **aggregate**, the objects representing the parts are called **components**

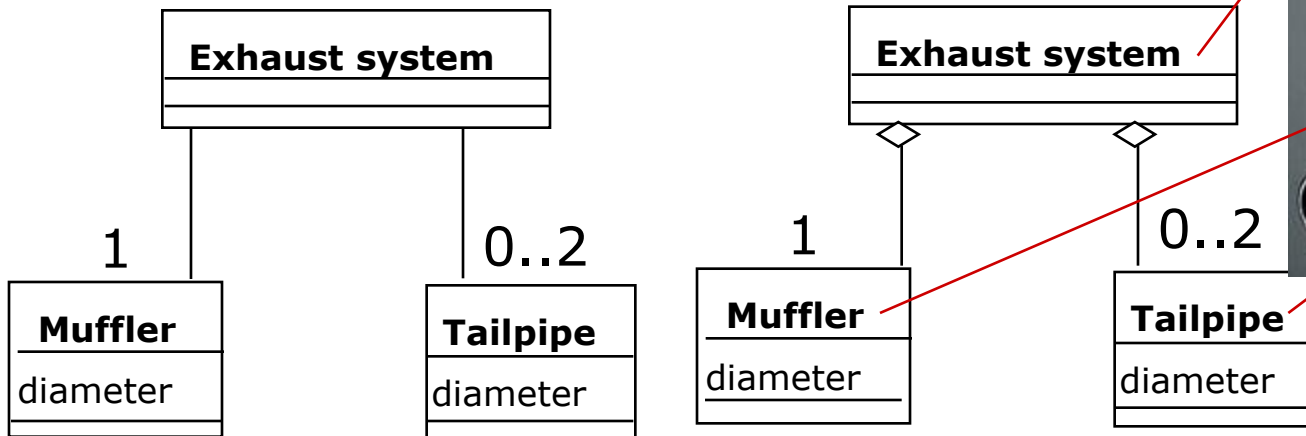

- A solid diamond denotes **composition**, a strong form of aggregation where components never exist without the aggregate
 - The association is in force throughout the life of the parts objects

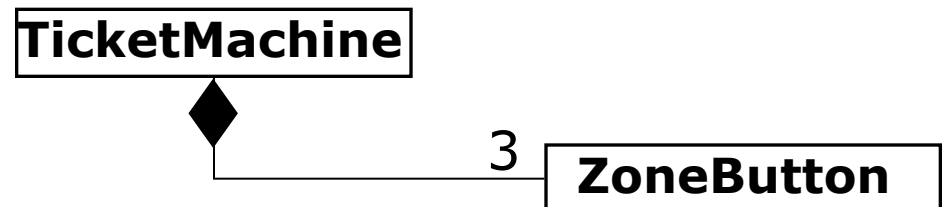

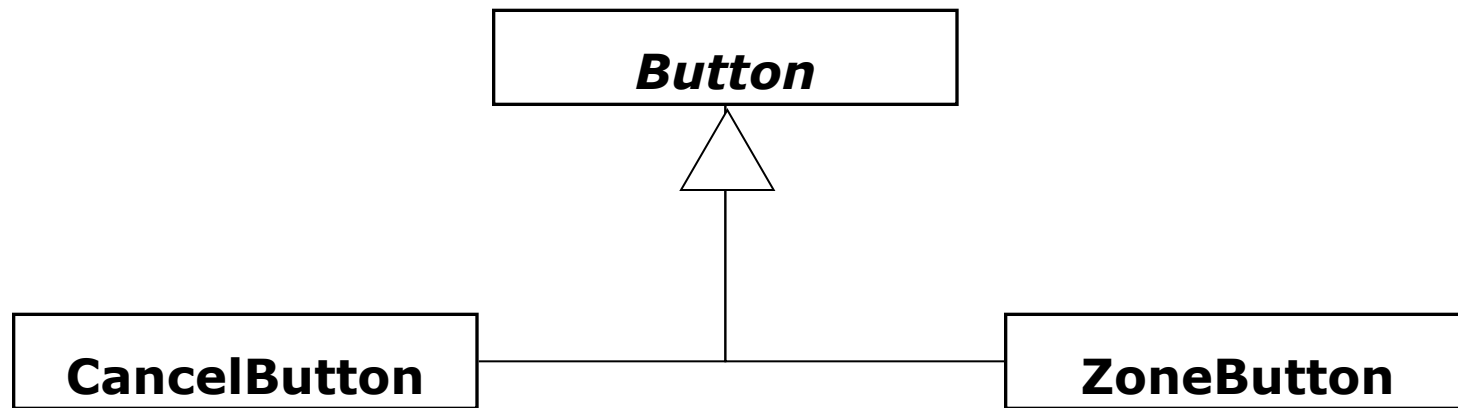

- The **children classes** inherit the attributes and operations of the **parent class**
- Read the triangle as an arrowhead, meaning "inherits from"
 - *CancelButton* inherits from *Button*
 - *ZoneButton* inherits from *Button*

Realization (Java: "implements")

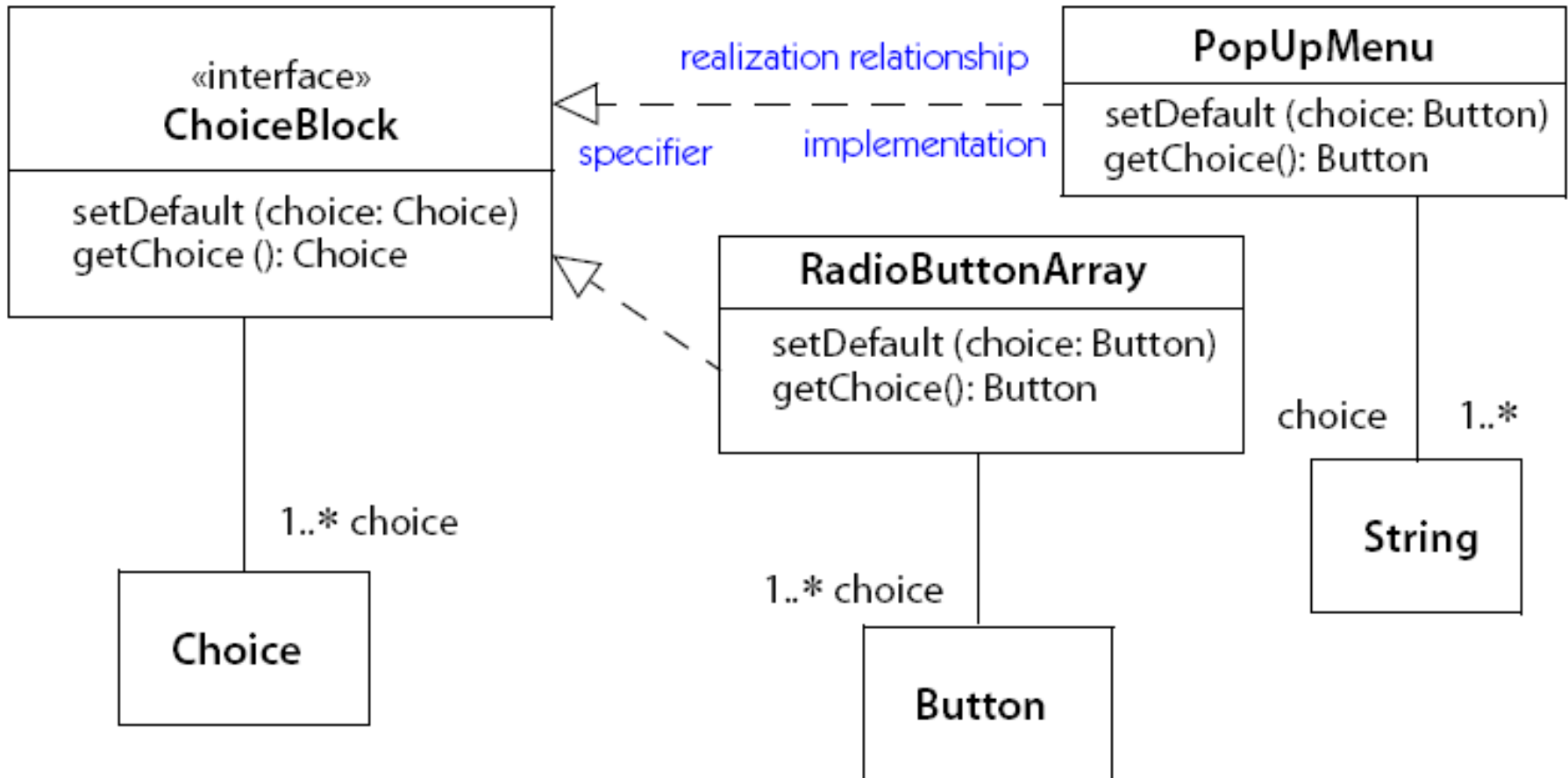

Example: Plato's and Aristotle's world views

Plato

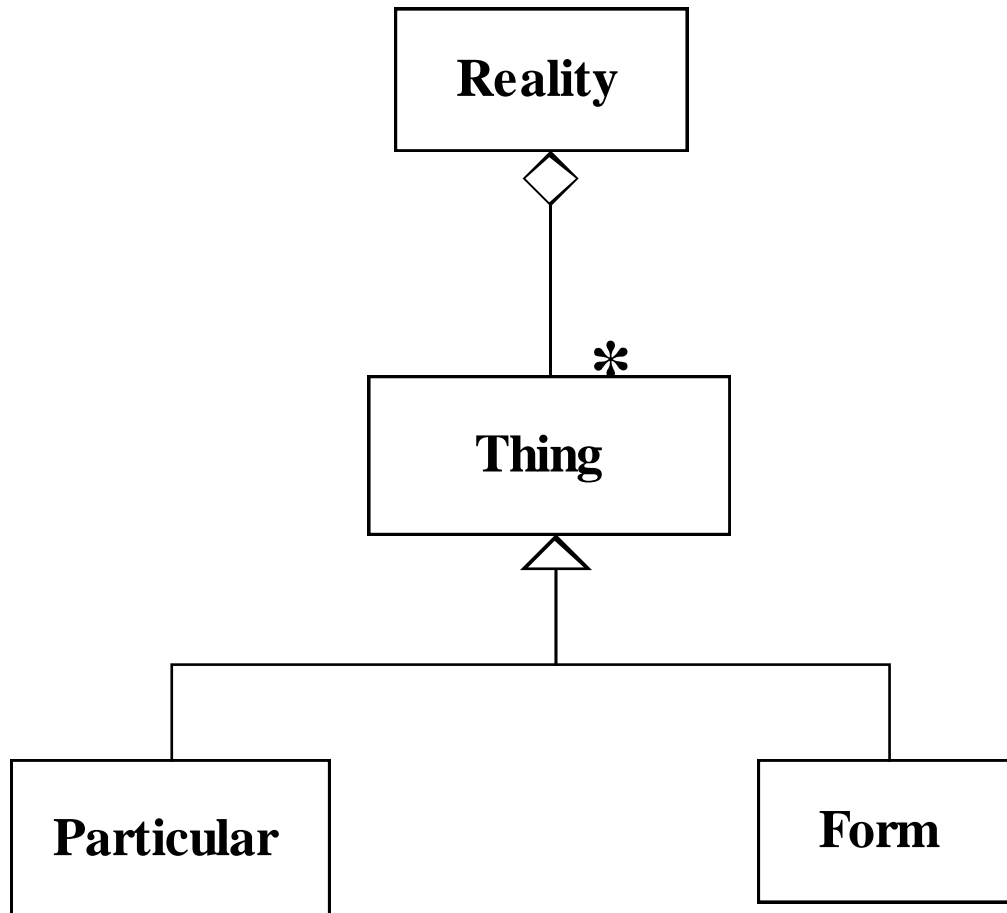

Aristotle

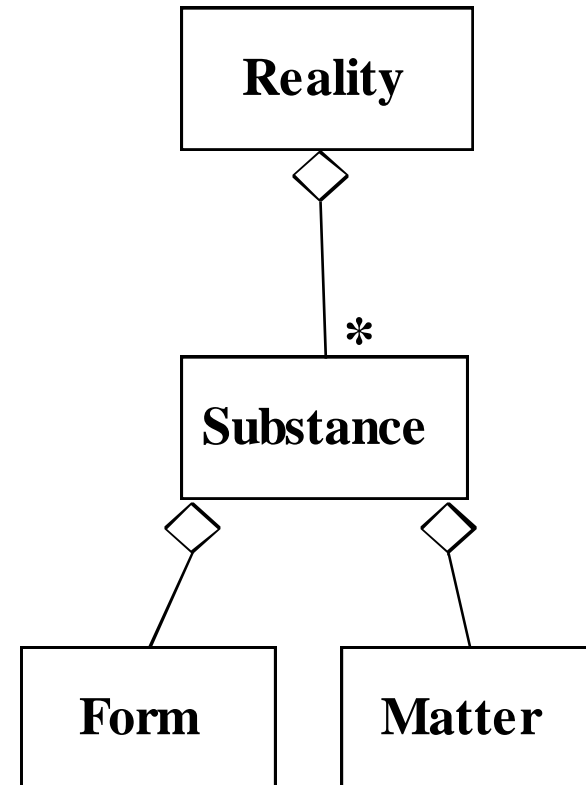

Association classes

- Individual associations between objects can have attributes
 - Described by an association class

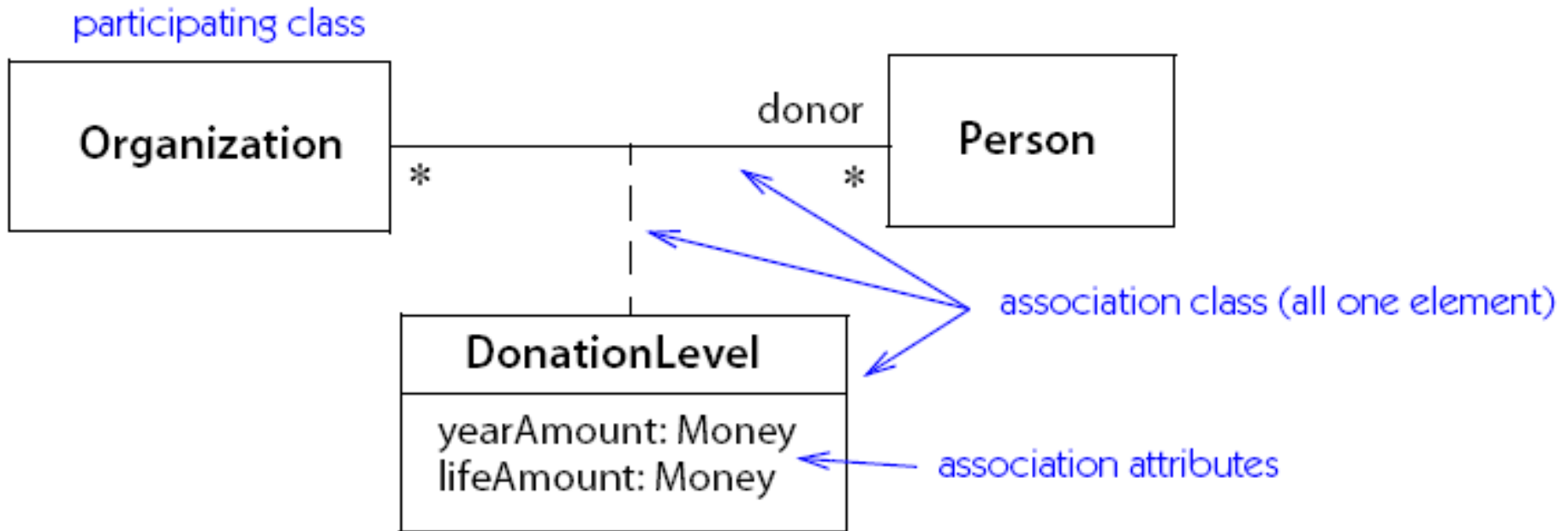

- Associations can be described by further details:

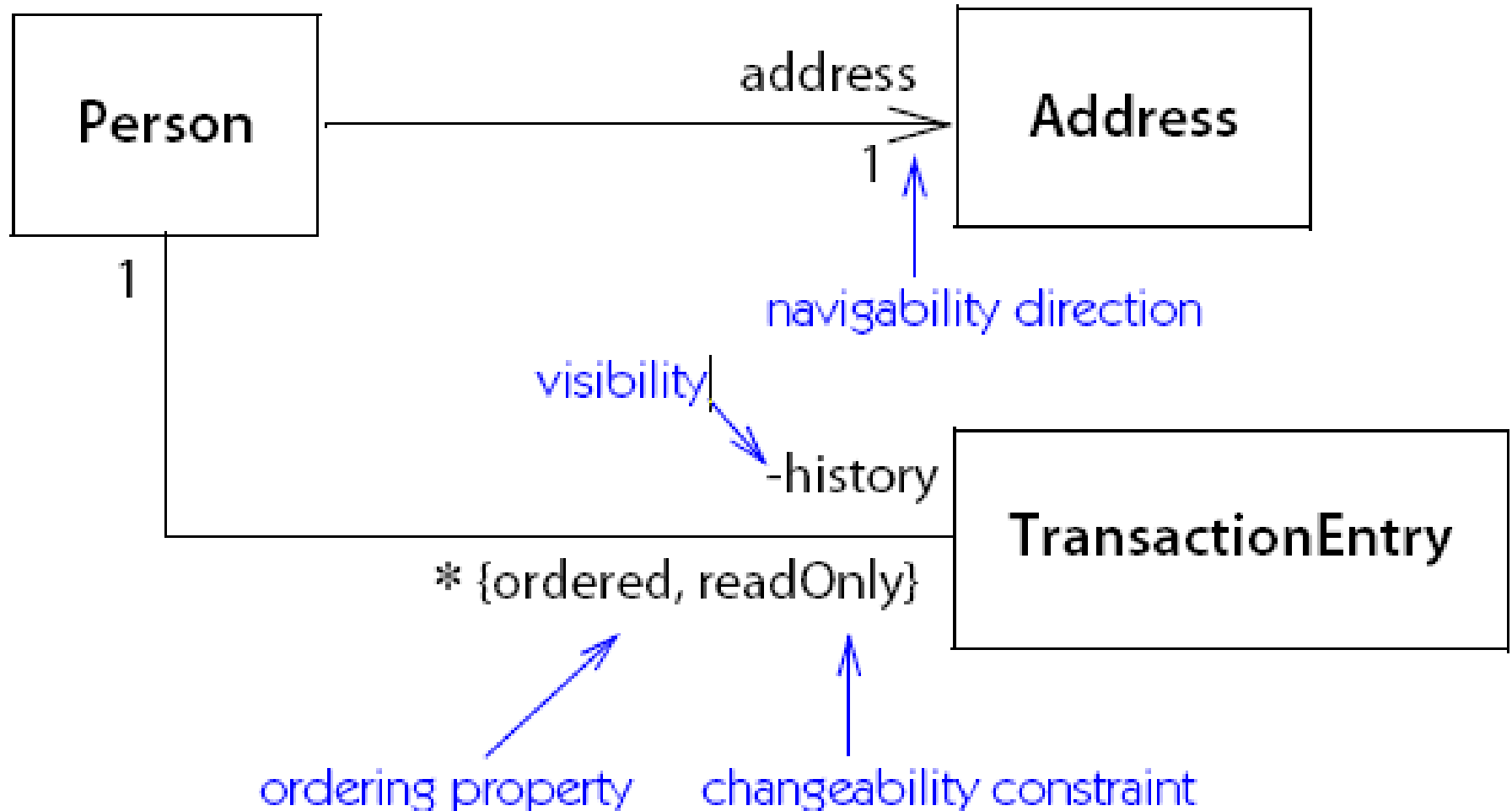

Class diagrams: theater example

- ..and some more notation details:
 - role name
 - XOR constraint
 - static operation

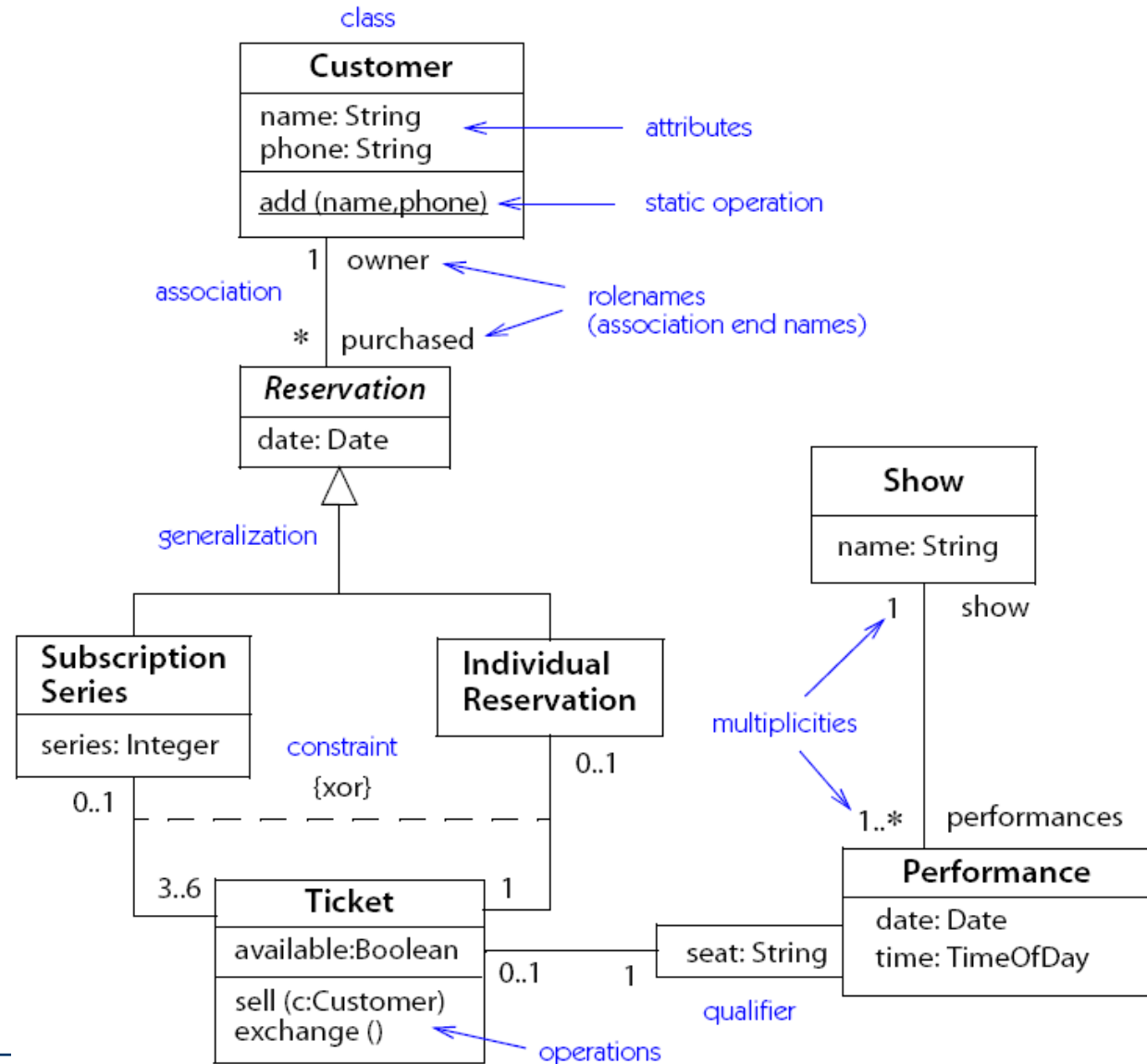

- A package is a UML mechanism for organizing elements into groups
 - Does not usually represent an application domain concept
- Packages are the basic grouping construct with which you may organize UML models to increase their readability

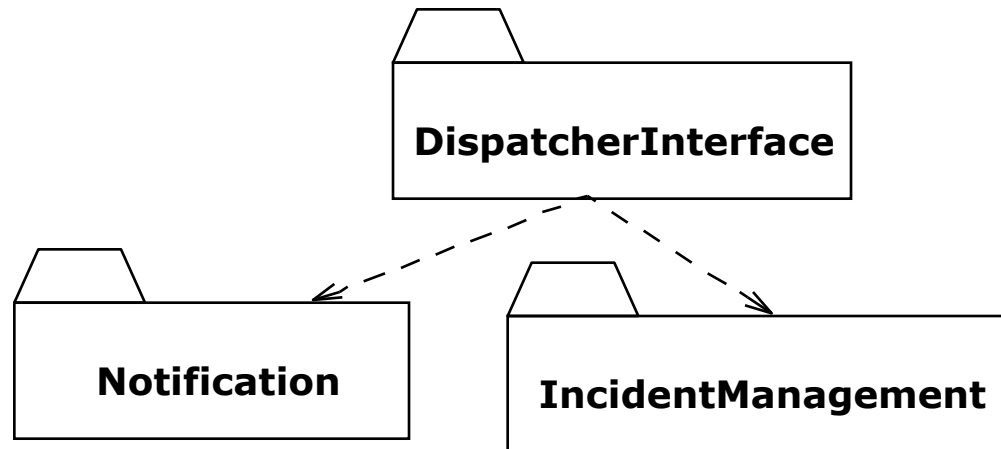

- A complex system can be decomposed into subsystems, where each subsystem is modeled as a package

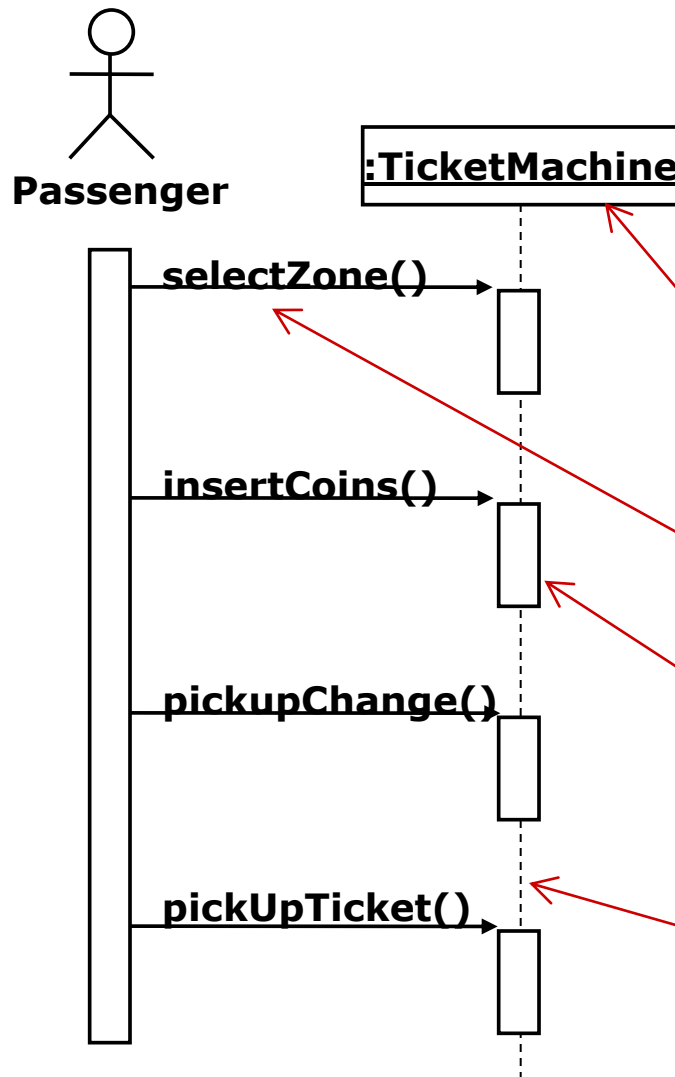

- Used during requirements analysis
 - To refine use case descriptions
 - to find additional objects ("participating objects")
- Used during system design
 - to refine subsystem interfaces
- **Objects** are represented by columns (*objname:classname*)
- **Messages** are represented by arrows
- **Activations** are represented by narrow rectangles
- **Lifelines** are represented by dashed lines

Nested messages

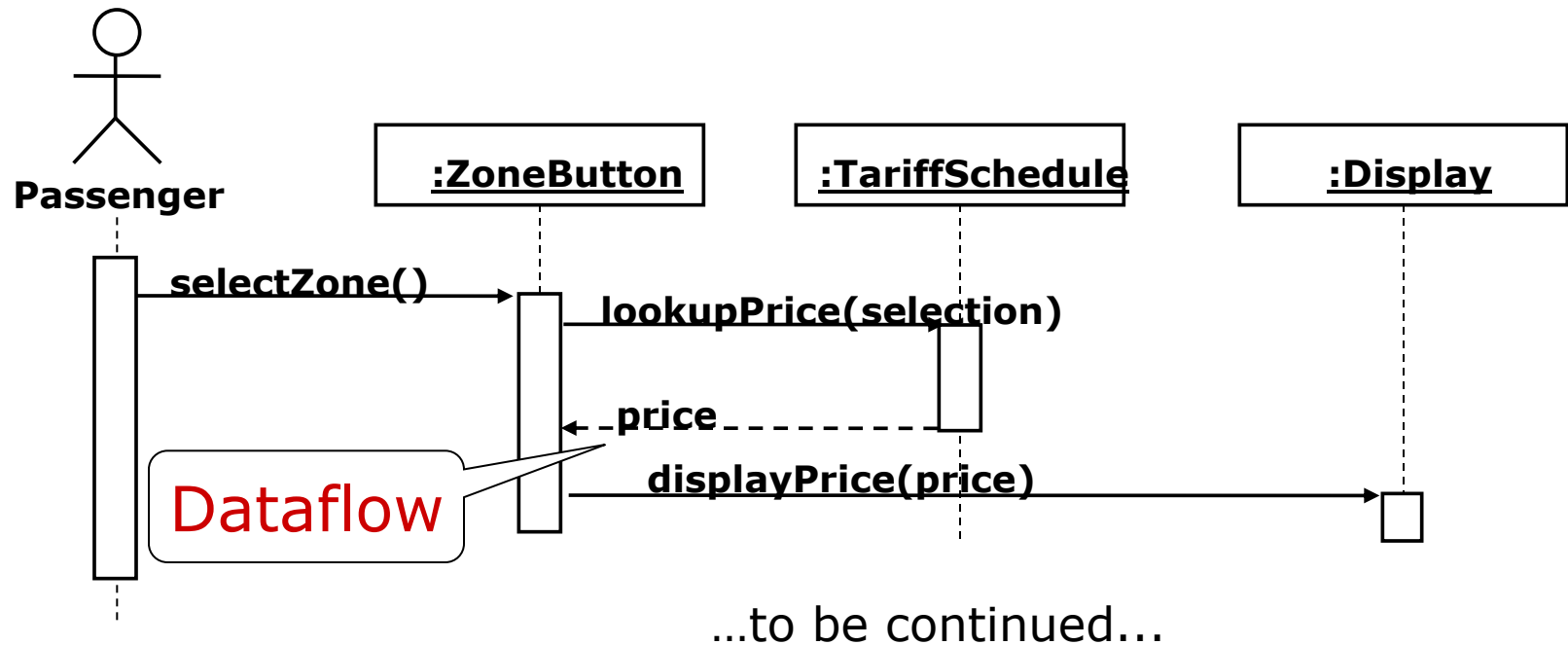

- The source of an arrow indicates the activation which sent the message
- An activation is as long as all nested activations (for normal calls)
- Horizontal dashed arrows indicate data flow
- Vertical dashed lines indicate lifelines

Sequence diagram: theater example

external call,
external return

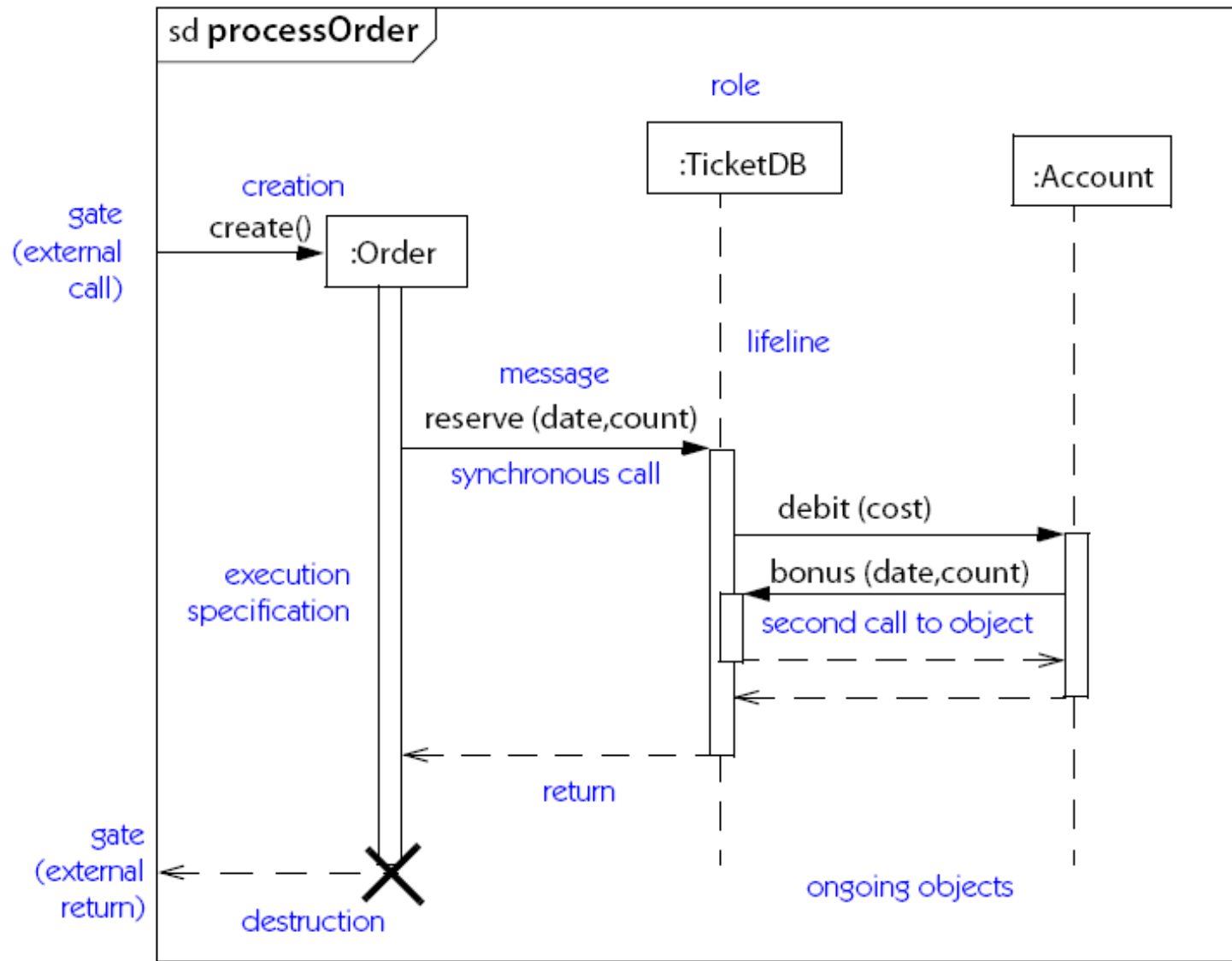

Advanced features

- creation
- nesting
- iteration
- conditions, branching
- destruction

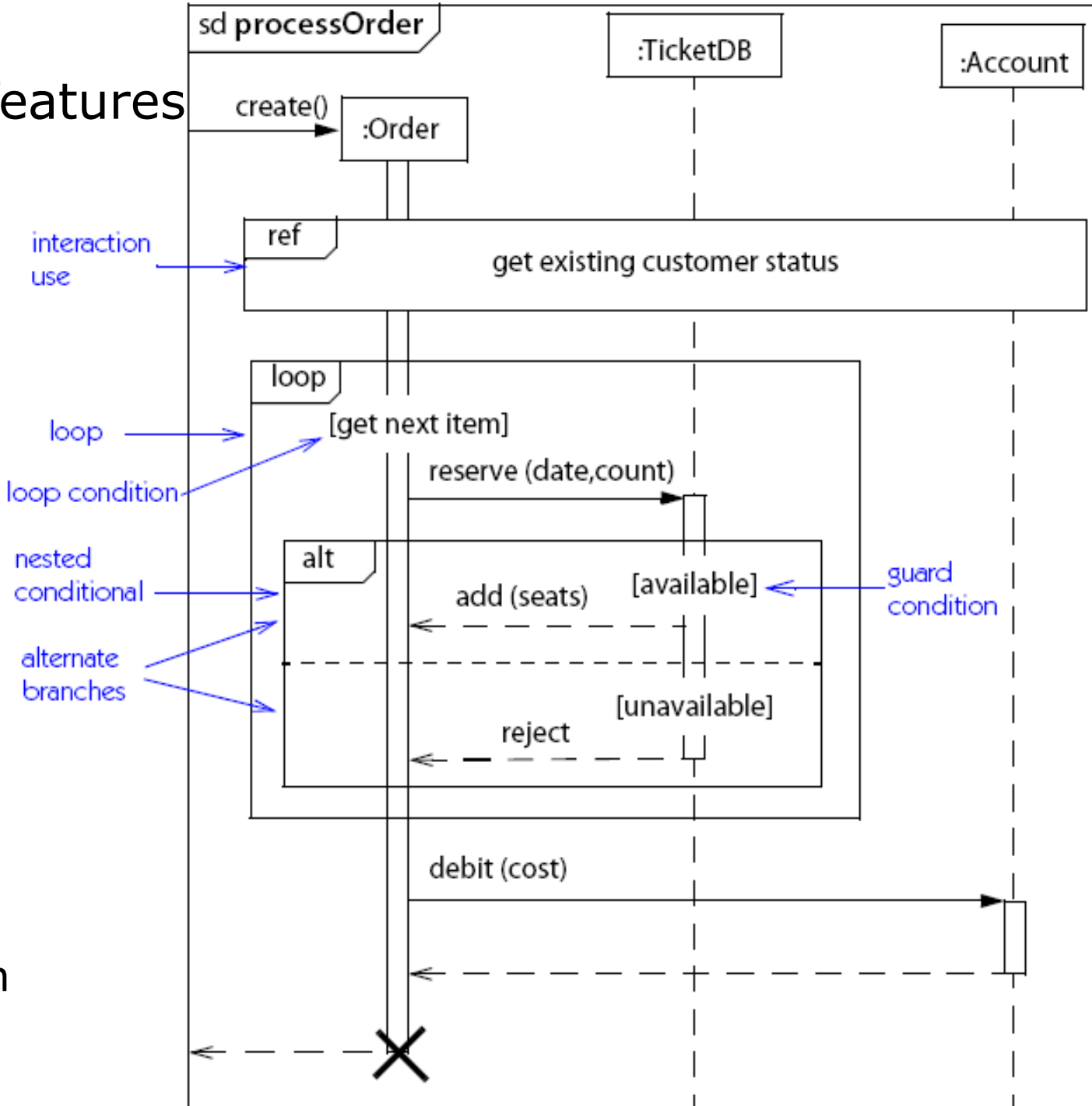

Sequence diagram summary

- UML sequence diagrams represent behavior in terms of object interactions
 - Useful to find missing objects
 - Useful for explaining design ideas
 - Describes examples only, no general specification
 - Time-consuming to build, but may be worth it
 - Complement the class diagrams (which represent structure)
- dynamic view
- static view
-

Statechart diagrams

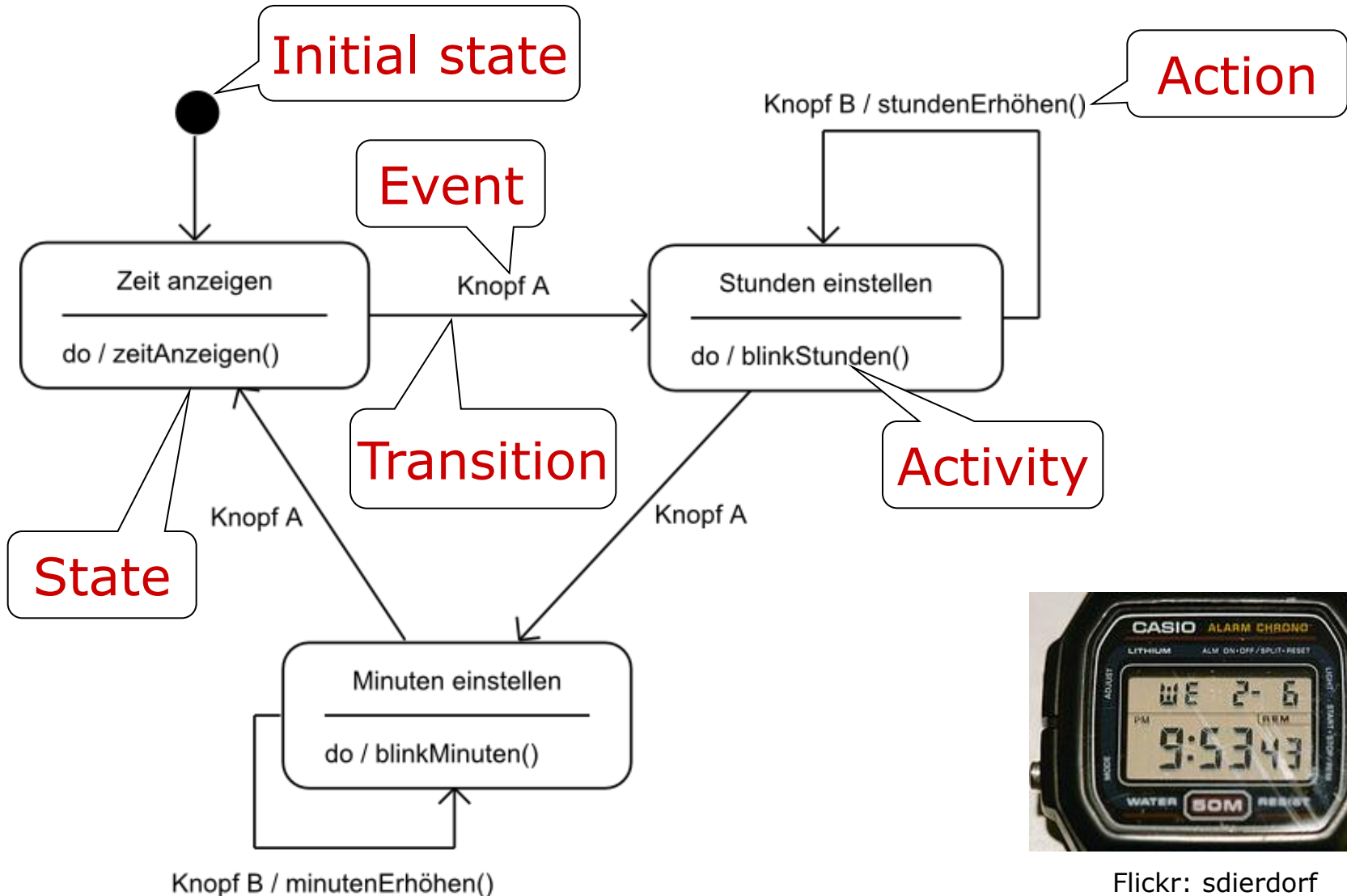

Flickr: sdierdorf

Transitions can be subject to guard conditions

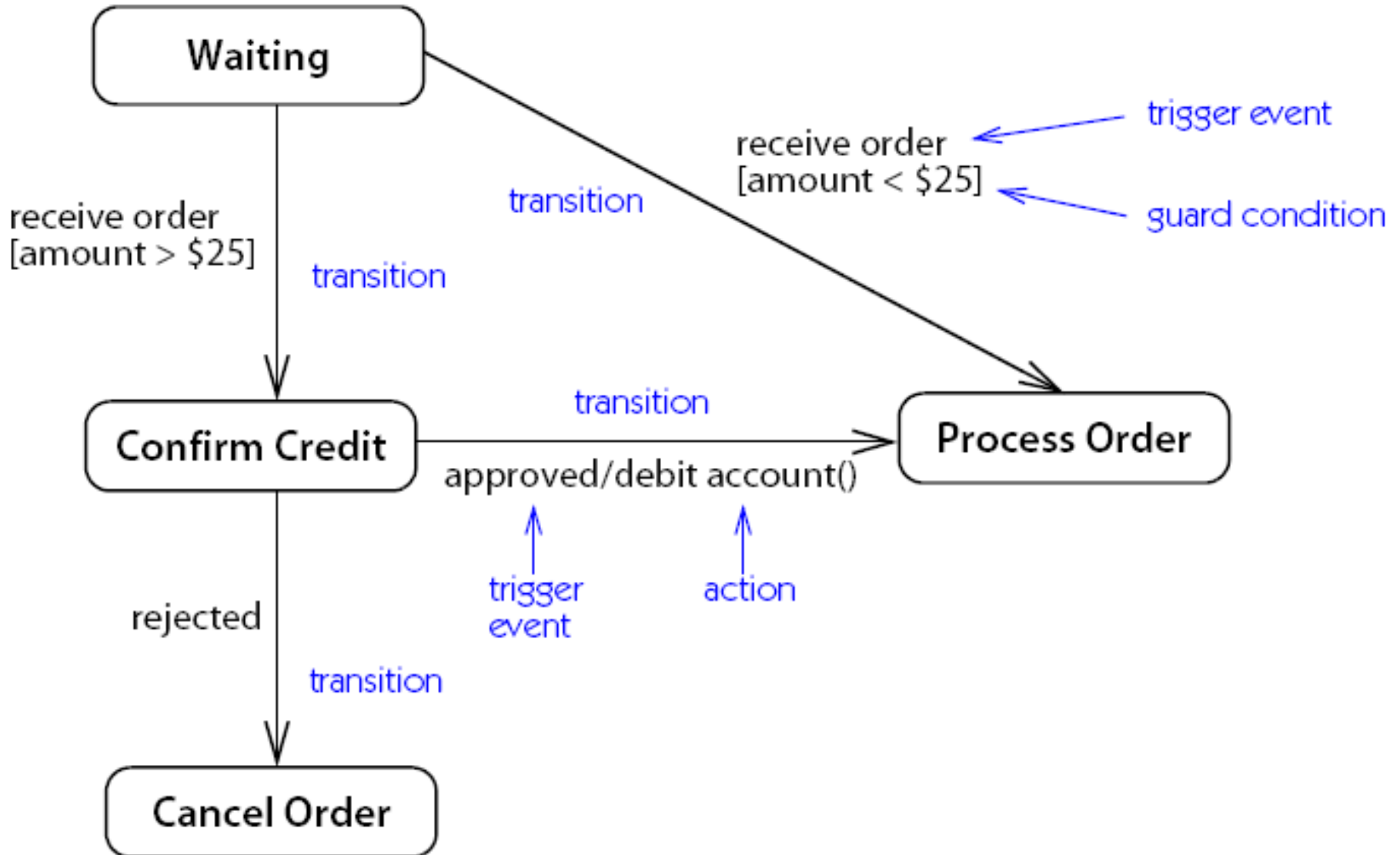

Parallel (orthogonal) states, explicit exits

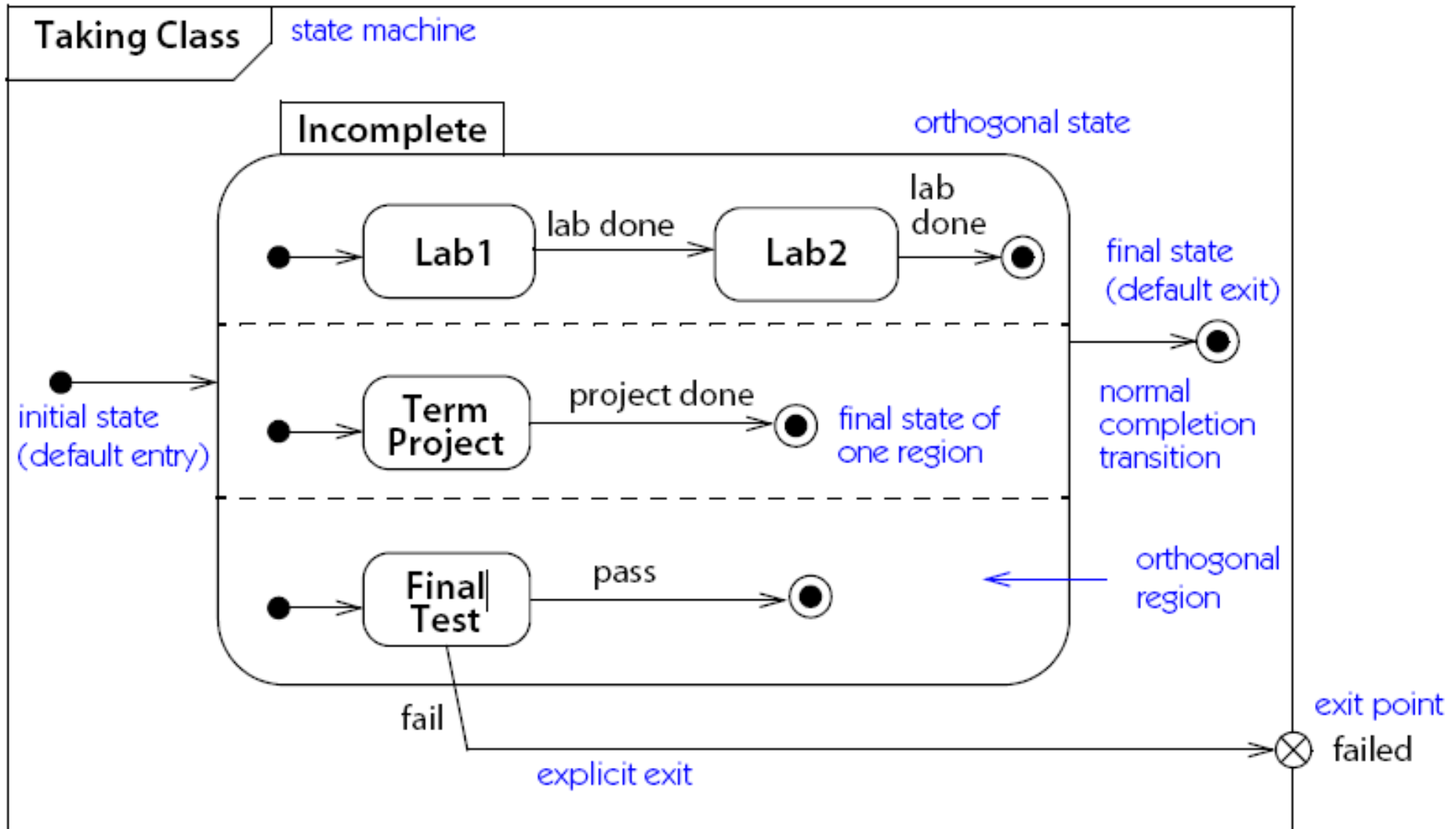

A transition is the consequence of an event

<i>Event Type</i>	<i>Description</i>	<i>Syntax</i>
call event	Receipt of an explicit synchronous call request by an object	op (a:T)
change event	A change in value of a Boolean expression	when (exp)
signal event	Receipt of an explicit, named, asynchronous communication among objects	sname (a:T)
time event	The arrival of an absolute time or the passage of a relative amount of time	after (time)

There can be multiple transitions at one state

- Actions can be annotated inside the state box
 - to avoid redundancy

state name

entry and exit activities

internal transitions

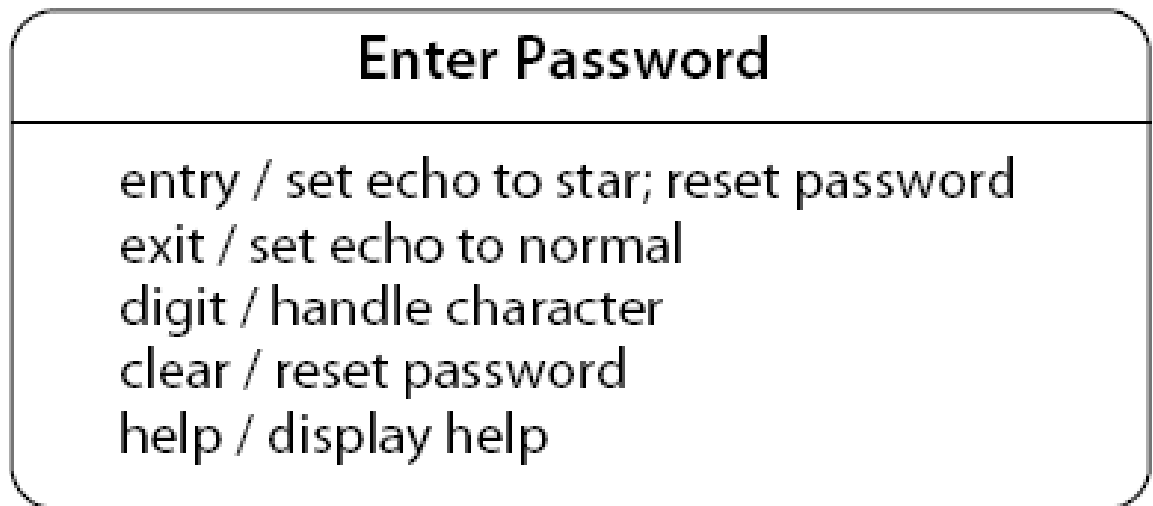
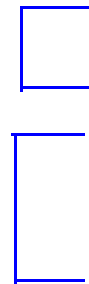

- also: do / some_activity
for an activity occurring throughout the state

- An activity diagram shows flow control within a system

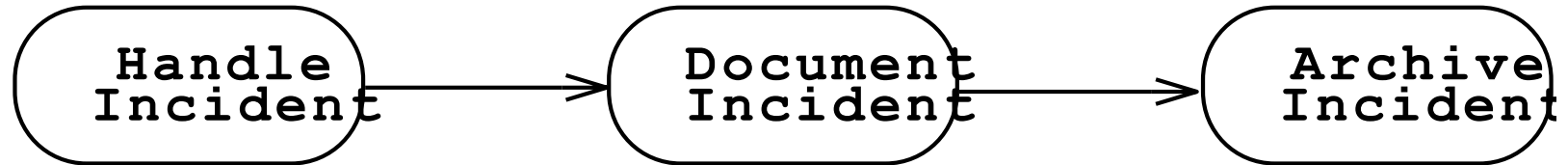

- A simple activity diagram is a special case of a statechart diagram in which states are activities ("functions")
- Two types of states:
 - Action state:
 - Cannot be decomposed any further
 - Happens "instantaneously" with respect to the level of abstraction used in the model
 - Activity state:
 - Can be decomposed further
 - The activity is modeled by another activity diagram

Statechart diagram vs. activity diagram

Statechart diagram for Incident (similar to Mealy Automaton)
(State represents some set of attribute values)

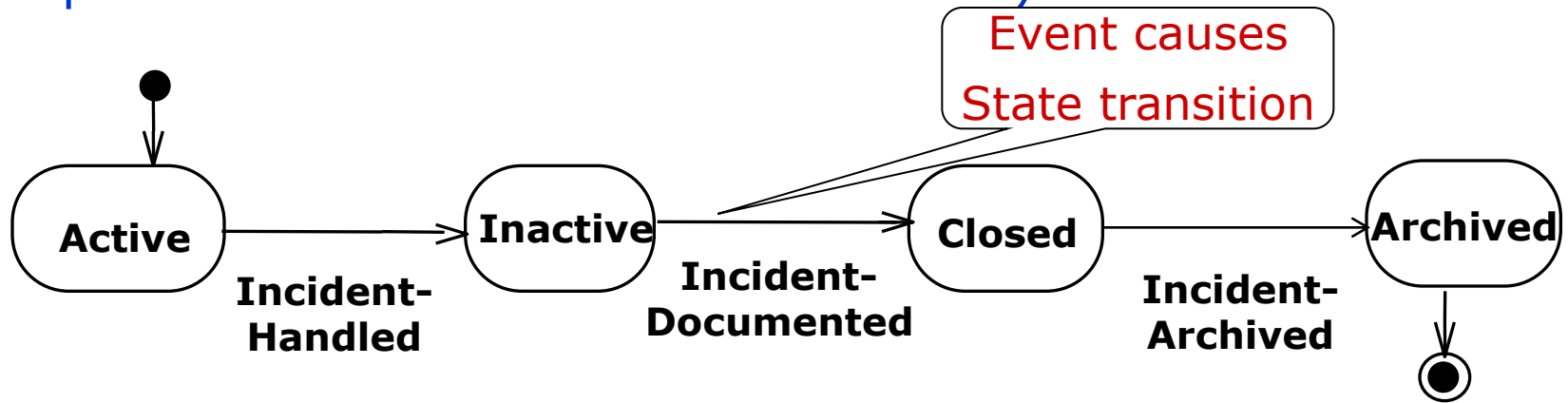

Activity diagram for Incident (similar to Moore Automaton)
(State represents some collection of operations)



Activity diagram: decisions

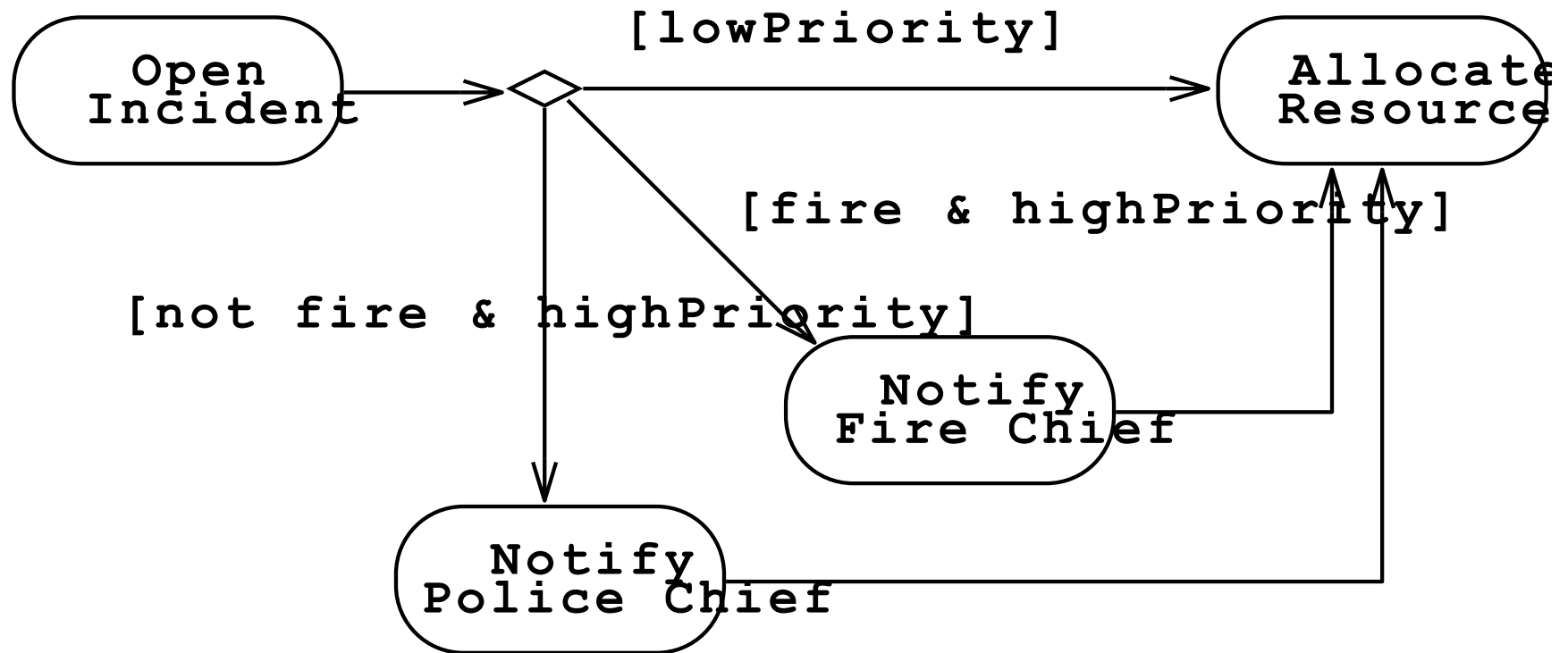

Activity diagrams: concurrency

- Synchronization of multiple activities
- Splitting the flow of control into multiple threads
 - corresponds to split states as seen above

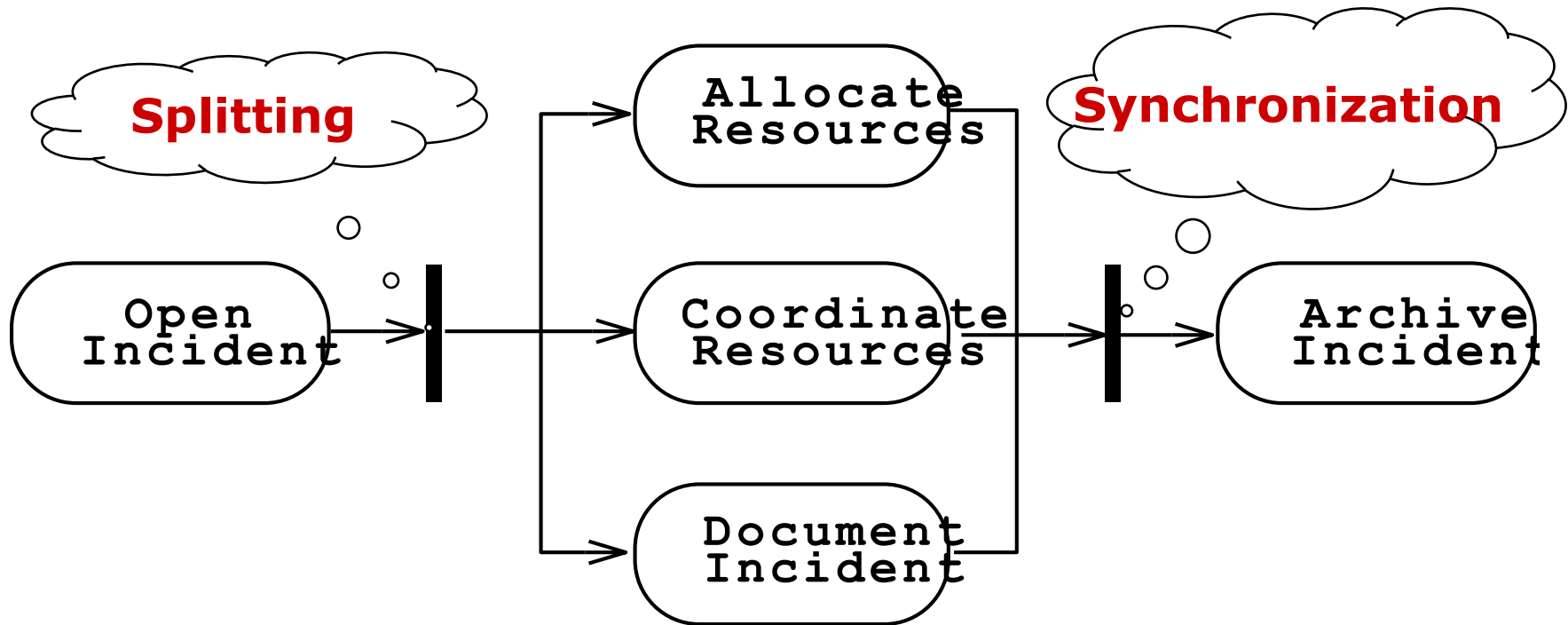

Activity diagrams: theater example

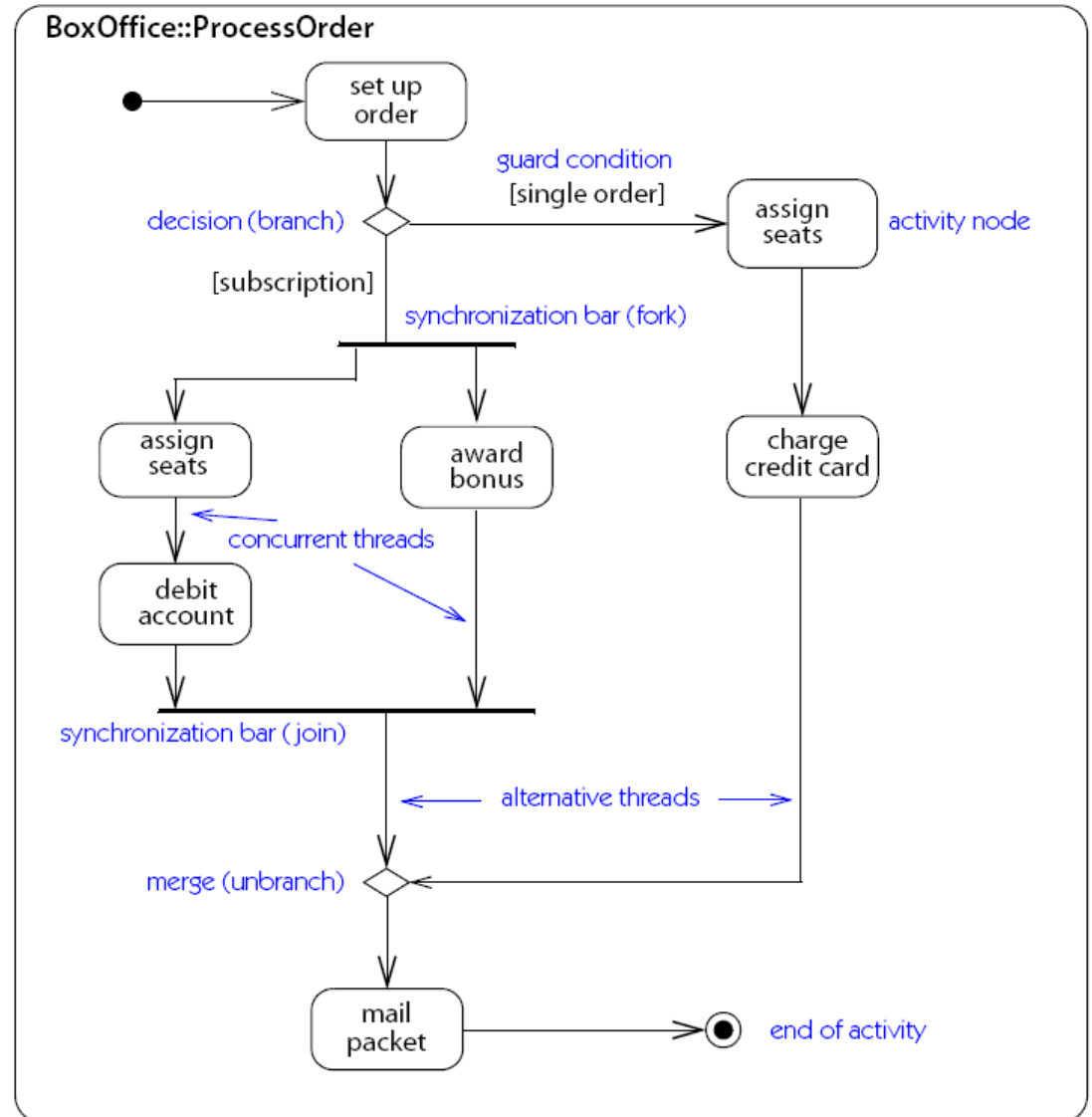

Further UML diagram types

Static view:

- Component diagrams, internal structure diagrams
 - Subsystems (components) and their interfaces
- Collaboration diagram
 - A part of a structure that collaborates for a specific purpose
- Deployment diagrams
 - Computers and which part of the system runs on which

Dynamic view:

- Communication diagrams
 - Equivalent to sequence diagrams, but embedded in an object diagram (shows both static structure and dynamic interaction)
- Interaction overview diagrams
 - Related to activity diagrams, for describing control flow

Components

- Components represent classes or subsystems (multiple classes)
 - The focus is on their interfaces

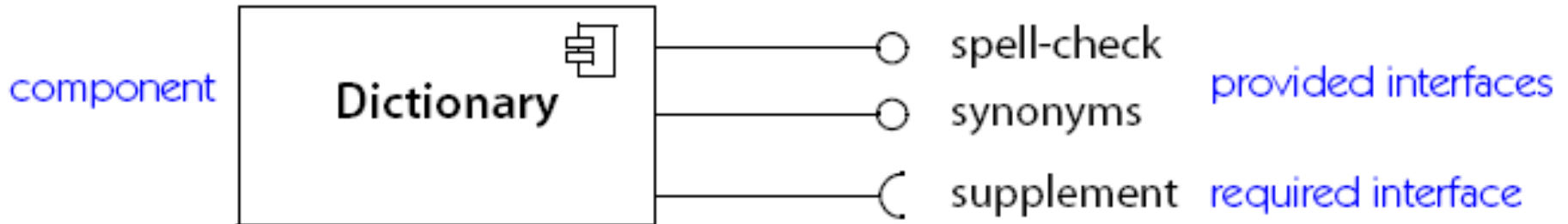

Component diagram, internal structure diagram

- Compositions of components
 - Component diagram: any composition
 - Internal structure diagram: forming another component

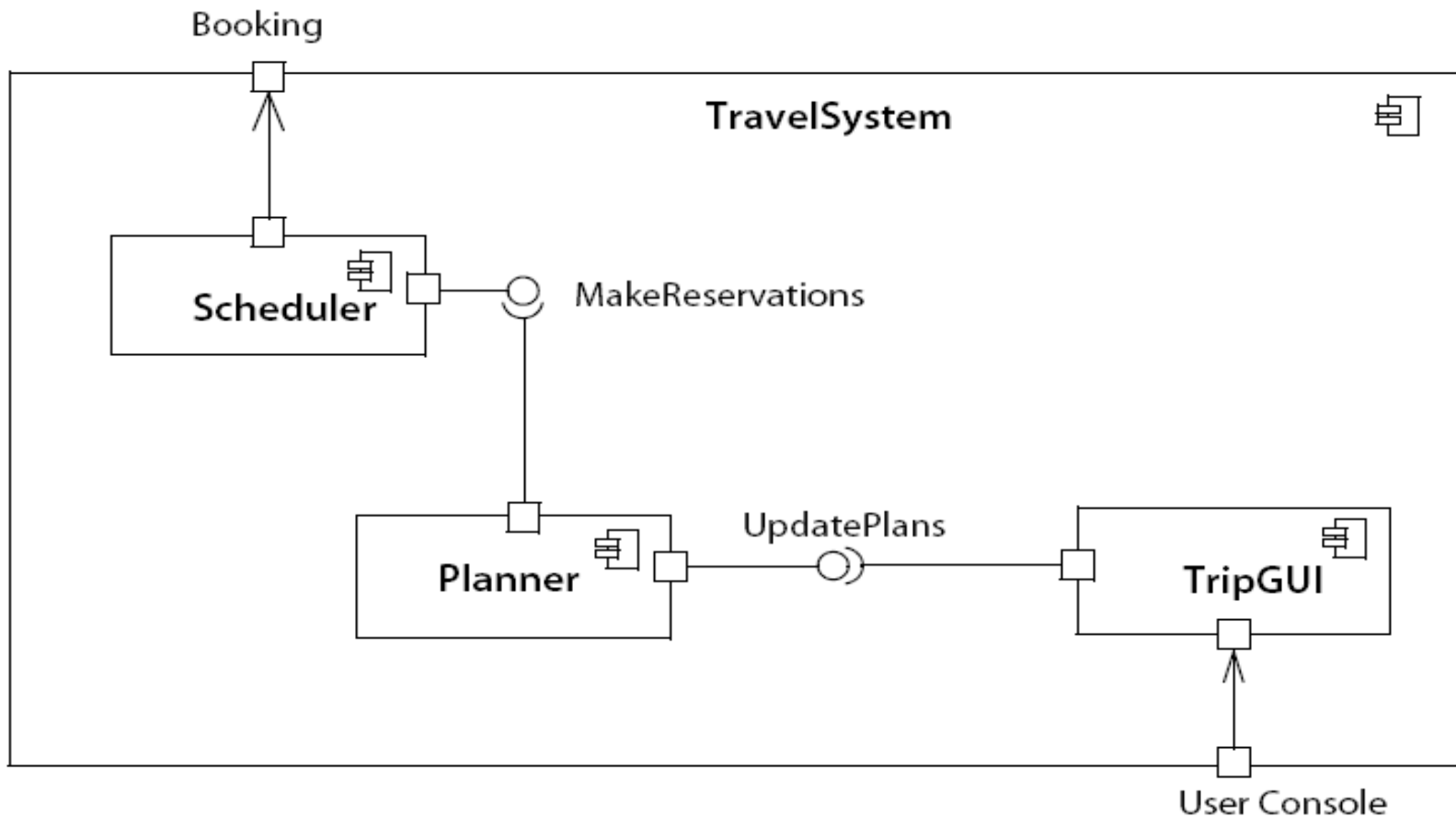

Collaboration diagram

- A view describing the associations of objects (instances!) for one specific purpose only
 - and describing the objects' roles for that context

collaboration

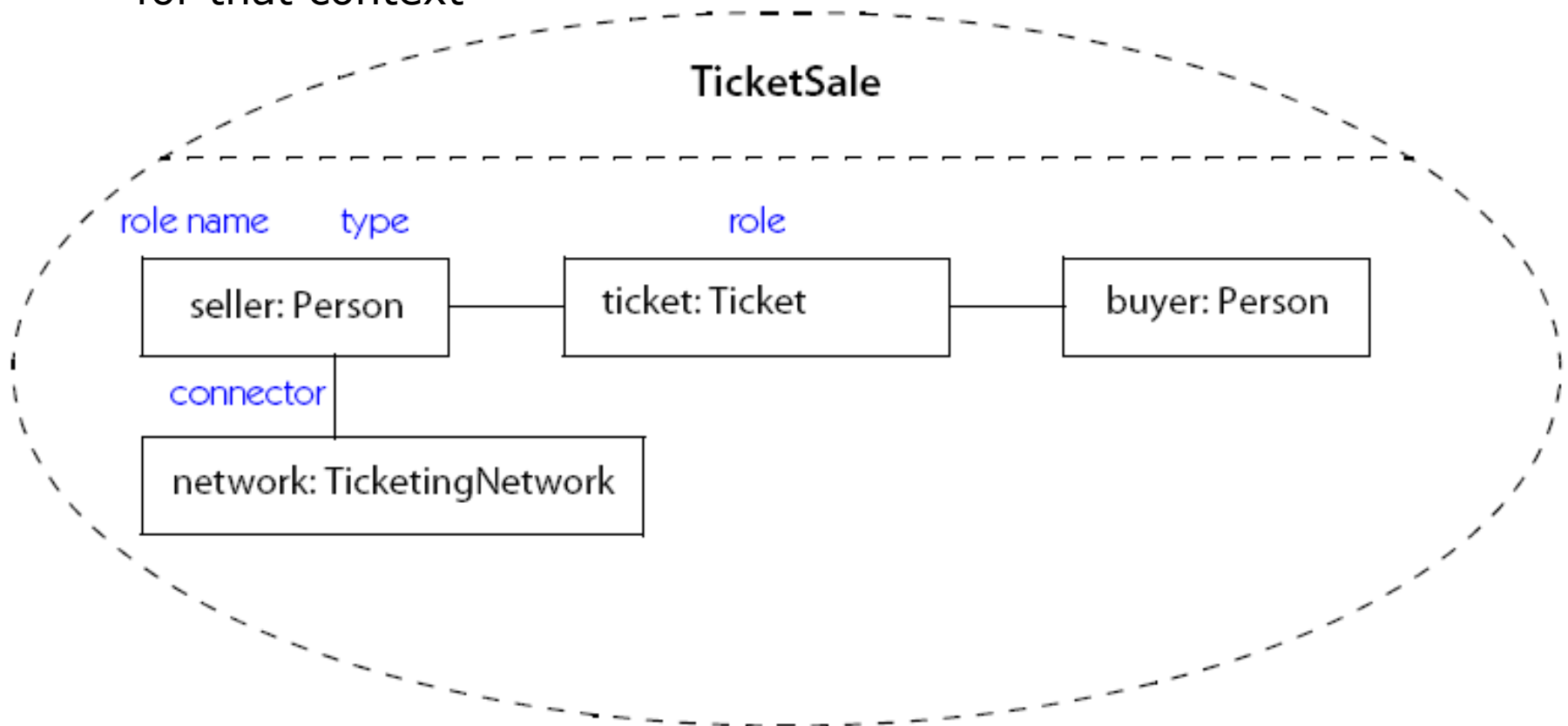

Deployment diagram

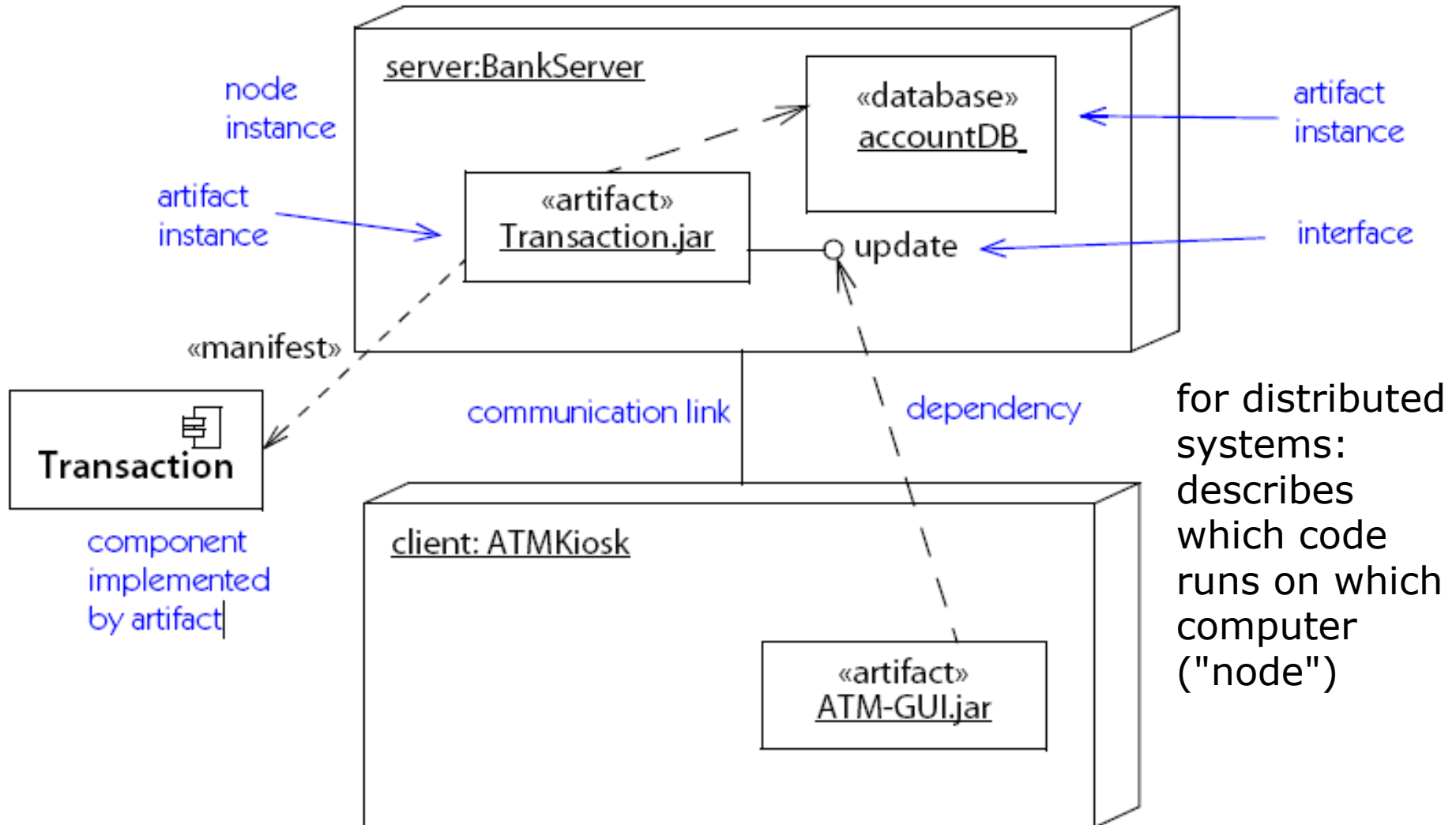

Communication diagram

- An object diagram with interaction annotations
 - Indicates interactions (like a sequence diagram) as well as object relationships (by the object diagram)

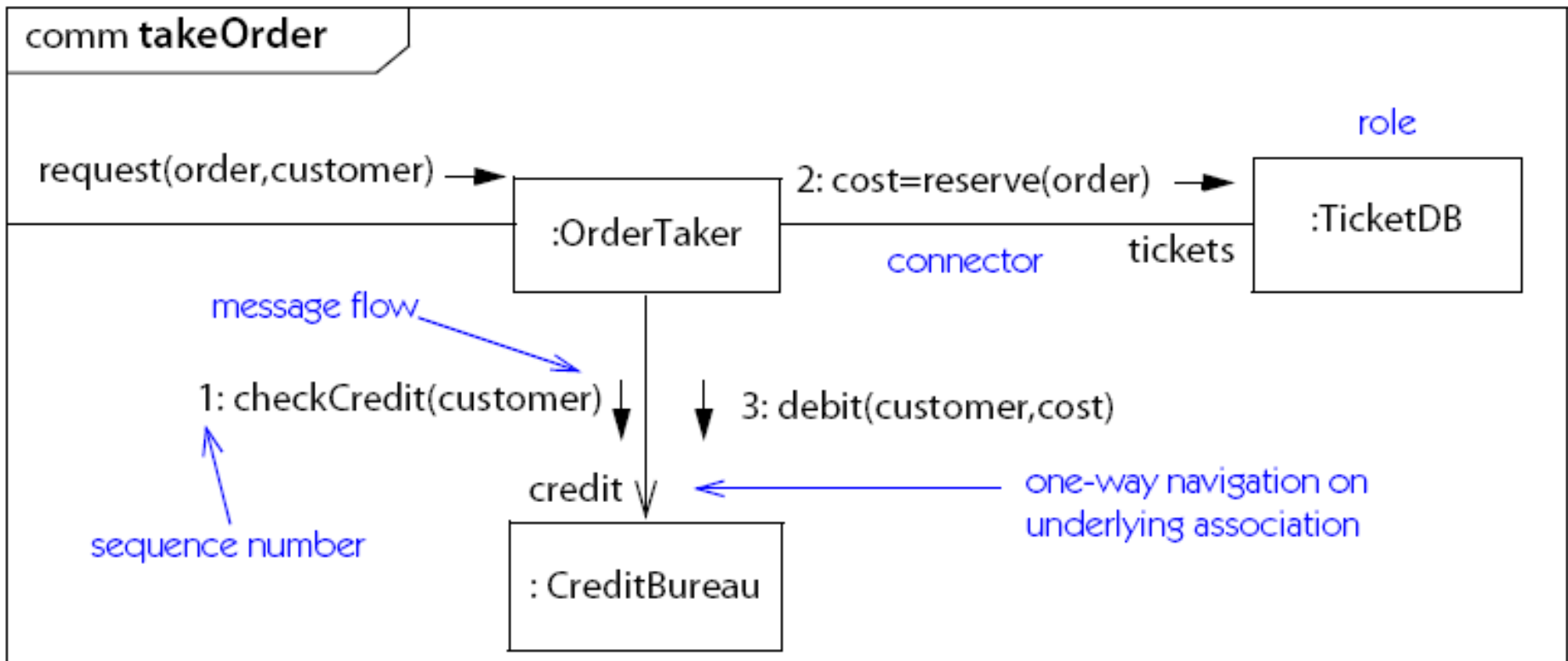

Interaction overview diagram

- A combination of activity diagram and sequence diagram:
 - activities may be sequence diagram fragments

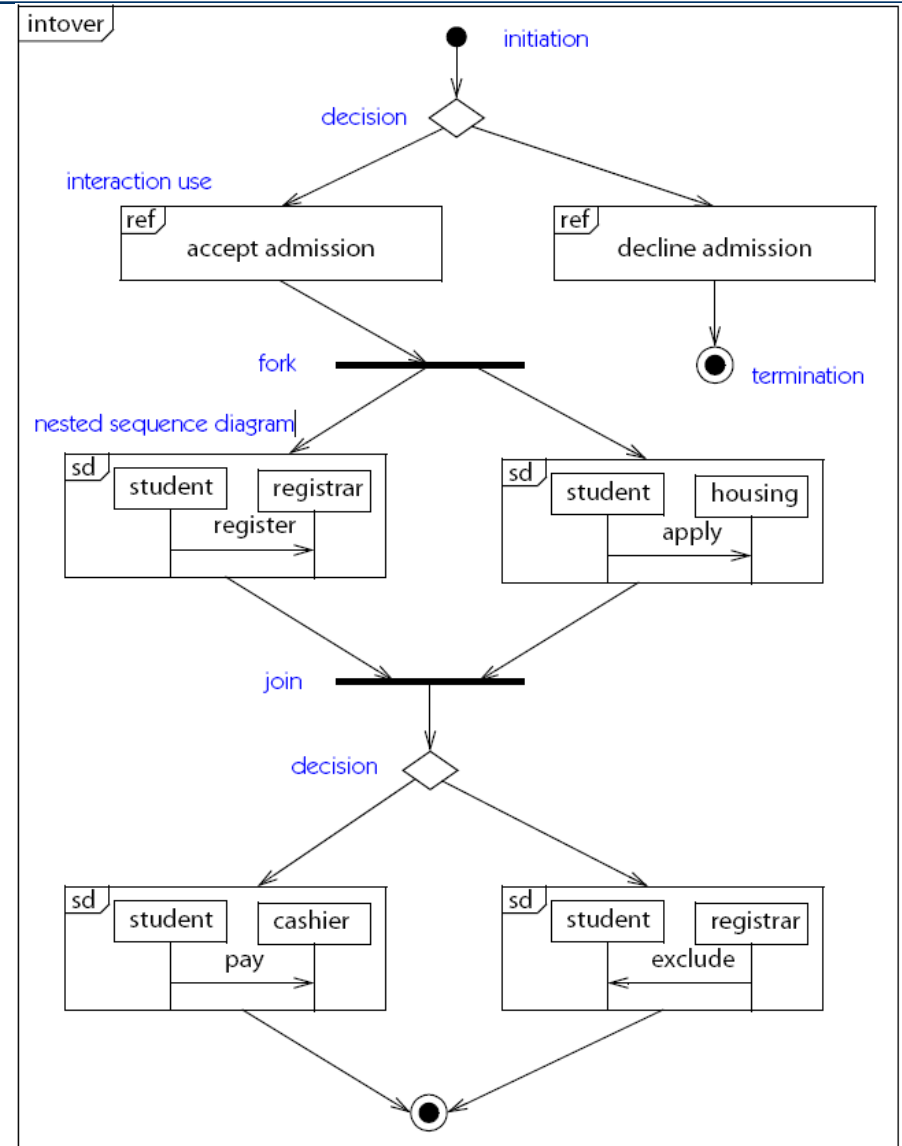
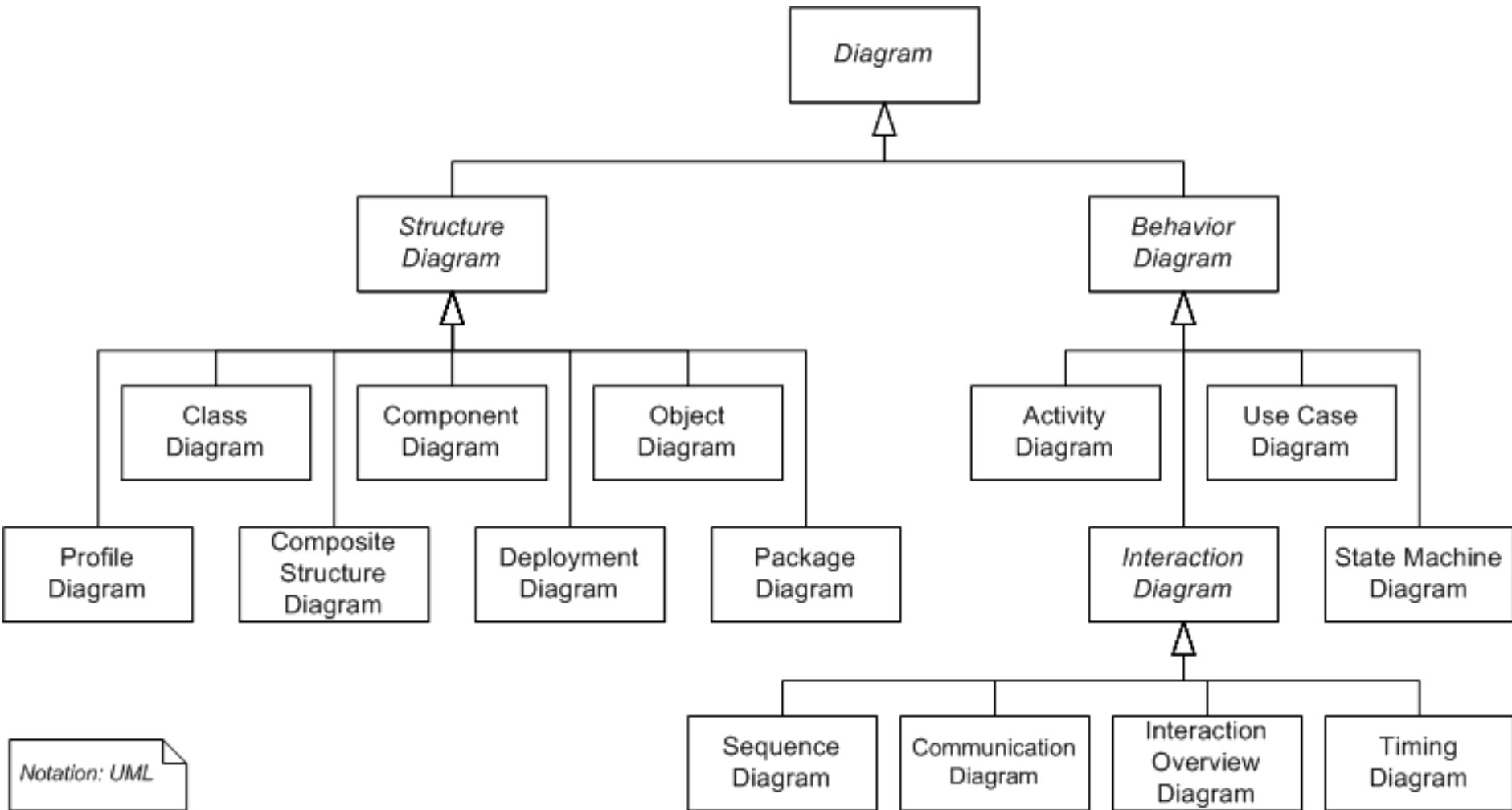

Diagram types overview (UML 2.2)



UML is described in UML itself

- The UML model describing UML is called the **UML metamodel**
 - It consists of UML class diagrams plus descriptive text
- Class level: Every kind of UML element (e.g. "*association*") is a class in that metamodel
 - The characteristics are described by attributes or associated classes
 - e.g. the UML metamodel contains a class *Association*
- Instance level: Every association in a specific UML model can be interpreted as an instance of the *Association* class in the UML metamodel
 - But actually there is much more than just one class:

The UML Metamodel of associations

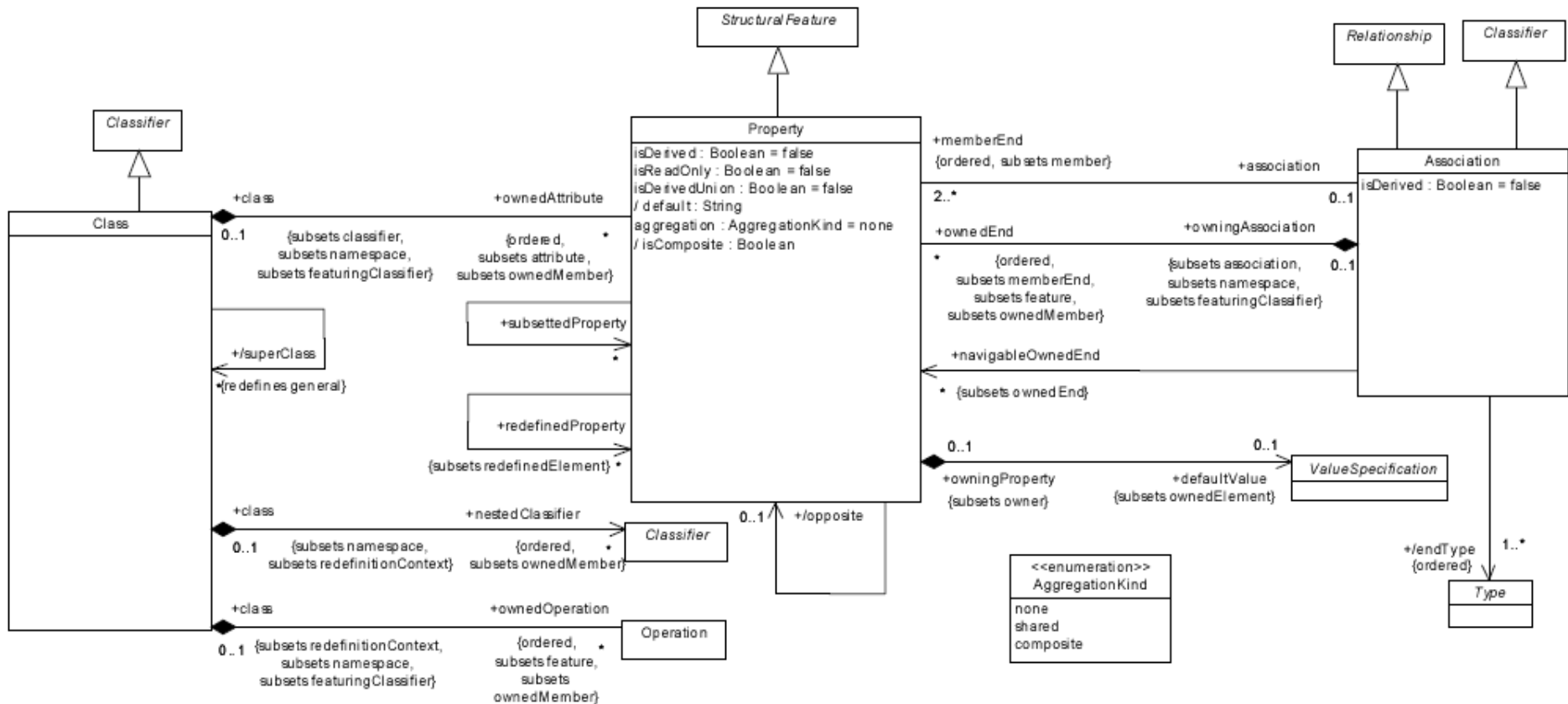

- Source: UML 2.0 Superstructure, section 7.2
 - <http://www.omg.org>

- **Profiles** add elements to the UML metamodel
 - A profile is a package that defines «stereotypes» and constraints that can be applied to certain metamodel elements

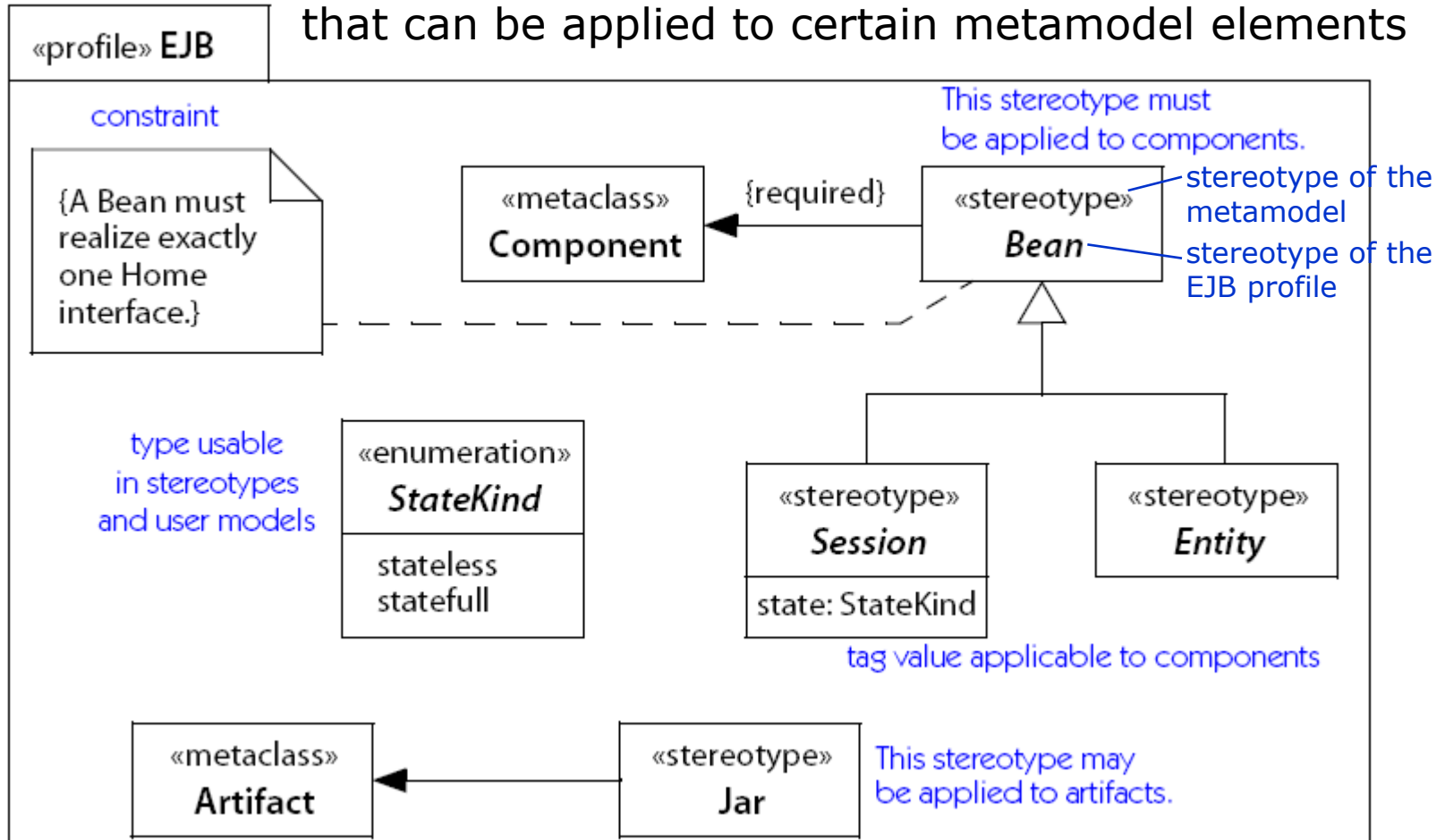

UML is fairly precise

- In this course, we will be using UML in a rather informal and imprecise manner
 - Our models are usually not very detailed
 - They leave many things unspecified (i.e., they are incomplete)
- However, one can produce fairly precise UML models
 - Such models have a reasonably well-defined meaning, as UML itself is specified in a semi-formal manner
 - No complete semantics have been specified for UML overall, though
 - There is **much** more to UML than can be said here
 - UML Infrastructure document: 200 pages
 - UML Superstructure document: 800 pages
- Precise UML usage is relevant for automatic code generation from the UML model
 - In some domains, such as telecommunication, complete subsystems are sometimes code-generated from UML models today

What should you know about UML?

- For all application domains:
 - Learn as much as you can about class diagrams
 - (soon probably also component diagrams)
 - Learn the basics of use case, sequence, communication, statechart, and activity diagrams
- For realtime and formally specifiable (sub)domains:
 - Also learn a lot about statechart diagrams
- If you want to make full use of UML CASE tools:
 - Learn a lot about packages and about profiles
- If you want to build UML CASE tools:
 - Learn about the UML metamodel (Warning: tough!)

- UML provides a wide variety of notations for representing many aspects of software development
 - Powerful, but complex language
 - Can be misused to generate unreadable models
 - Can be misunderstood when using too many exotic features
 - Many people who claim to "know UML" actually know very little
- For now we concentrate on a few notations:
 - Functional model: Use case diagram
 - Object model: class diagram
 - Dynamic model: sequence diagrams, statechart and activity diagrams

- James Rumbaugh, Ivar Jacobson, Grady Booch:
"The Unified Modeling Language Reference Manual", Second Edition (UML 2.0), Addison-Wesley 2005.
 - this is also the source of the figures with [blue annotations](#)
- James Rumbaugh, Ivar Jacobson, Grady Booch:
"The Unified Modeling Language User Guide", Second Edition (UML 2.0), Addison-Wesley 2005.
 - actually teaches how to *use* the UML
 - this lecture did not do this, but some of the rest of the course will
 - less misleading than some other books on the topic

The current version of UML is 2.3 (May 2010).

Thank you!

- The next few slides present a number of details in the notation of
 - Classes (Class diagrams)
 - Associations (Class diagrams)
 - Interfaces (Class diagrams)
 - States (Statechart and Activity diagrams)

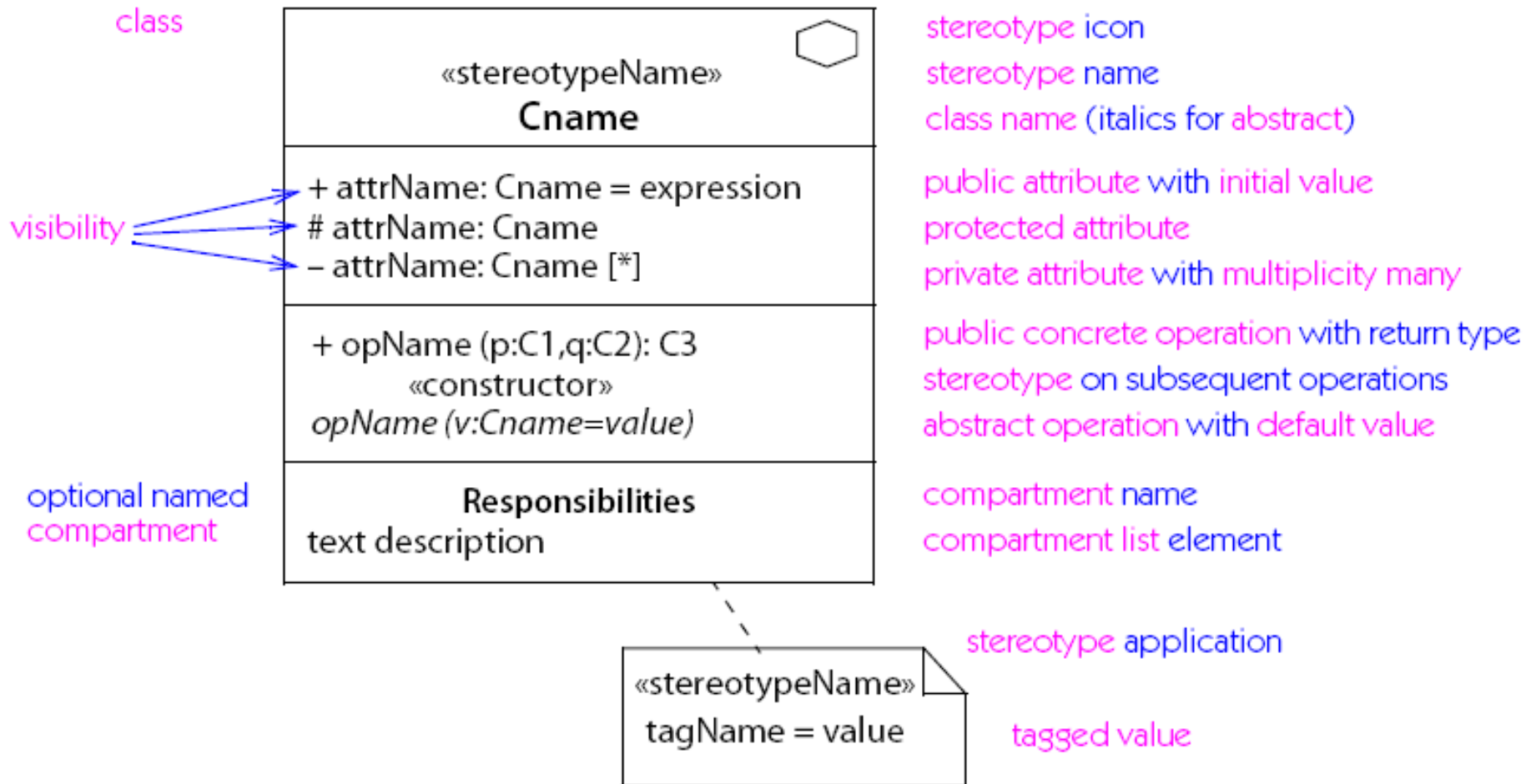

Details: Association

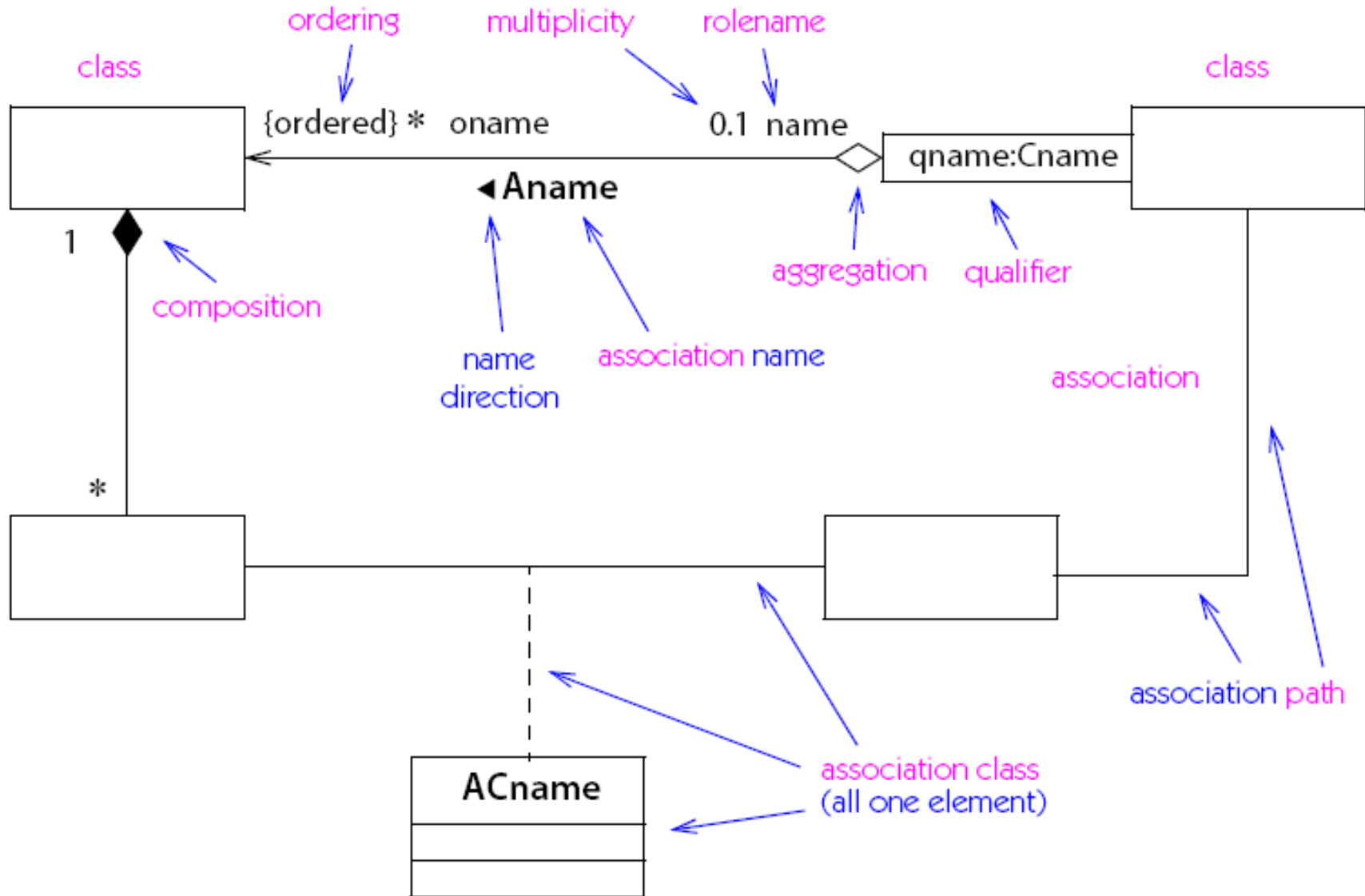

Details: Interfaces

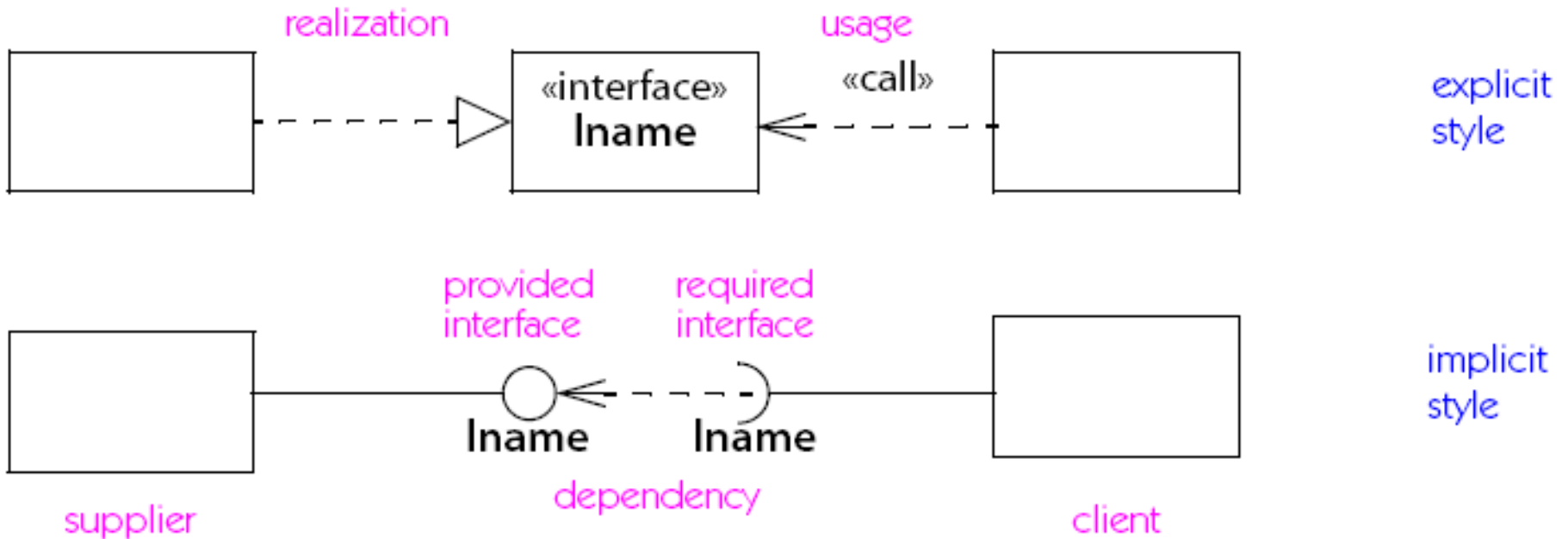

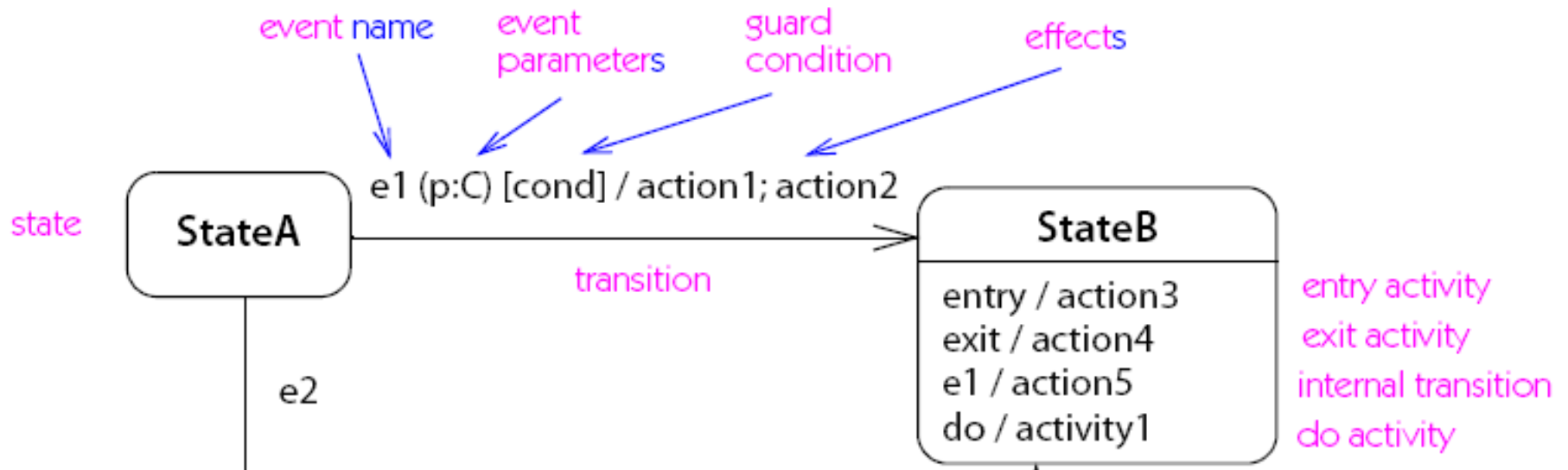

And for activity diagrams:

- Action: a primitive operation
 - i.e., primitive at the UML level
- Activity: a composite operation
 - describable as an activity diagram, i.e., composed of actions, other activities, splits, joins, branches, loops etc.