

# Chapter 9

## Load Balancing Problem

## 9.1 Introduction

### Assumptions

- Programs are dynamic, i.e. threads can be created and deleted at any time and at any place.
- The parallel machine is not empty.
- We employ multiprogramming operation without partitioning, i.e. threads of different programs may share the processors.
- Load consists of machine instructions to be executed, i.e. transferable load consists of
  - threads that are migrated
  - work packets that are sent to server threads.
- **Goal:** Even distribution with low communication cost

- With load balancing between processors we want to achieve the following goals:
  1. Avoid unused processor capacity
  2. Equal progress of all threads of a parallel program
  3. *Fairness* in case of multiprogramming
- Pursuing goal 1 only is called **load sharing**.
- Load sharing is finished when each processor has at least one thread to execute.
- Goals 2 and 3 are dealt with by **load balancing** which tries to equally utilize all processors.

# Load sharing vs. Load balancing

Load situation without any load distribution

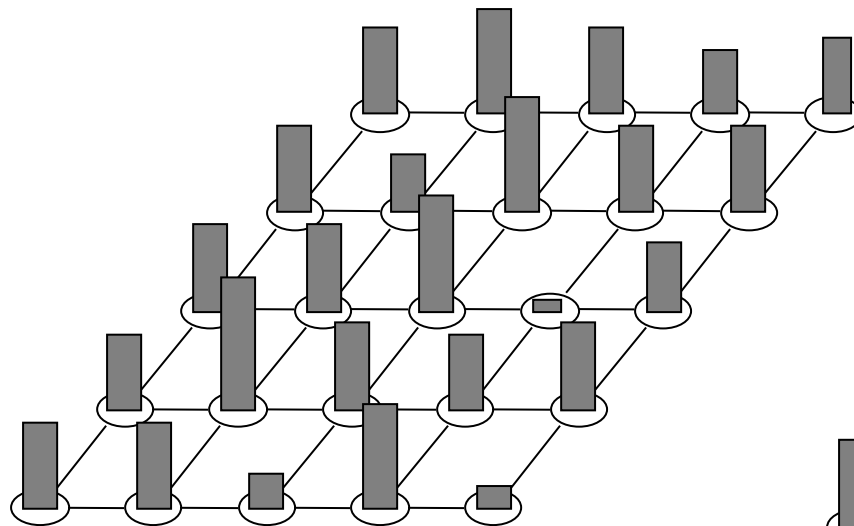
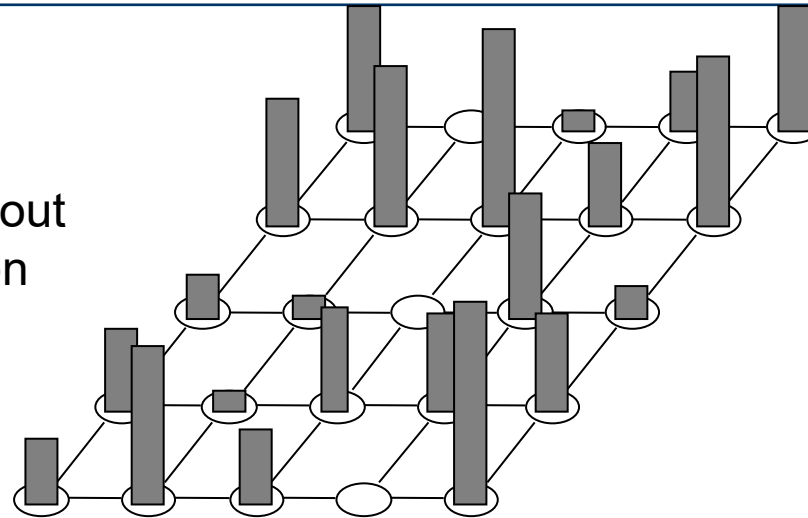

After load sharing

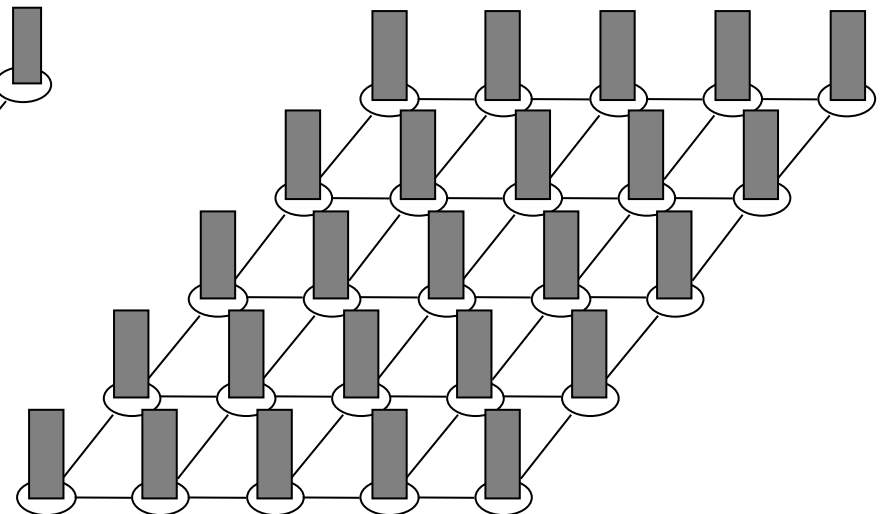

After load balancing

# Load balancing using thresholds

- Between load sharing and load balancing there is a pragmatic compromise that differentiates only between three possible load states:
  - underloaded: node can accept more threads.
  - well loaded: node can neither take more threads nor does it want to give away.
  - overloaded: node wants to give away threads.
- Usually we define two threshold values  $s_u$  and  $s_o$ , that are used to specify the load state:

$$state_k := \begin{cases} \text{underloaded, if } B_k < s_u \\ \text{well loaded, if } s_u \leq B_k \leq s_o \\ \text{overloaded, if } s_o < B_k \end{cases}$$

- A load distribution mechanism is then limited to only those nodes that are either under- or overloaded, which may reduce the number of nodes involved significantly.

Load allocation

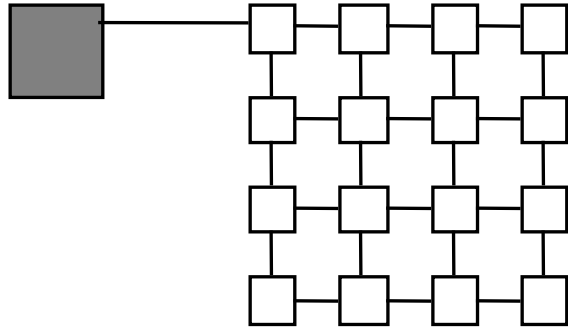

With front-end node

Load allocation

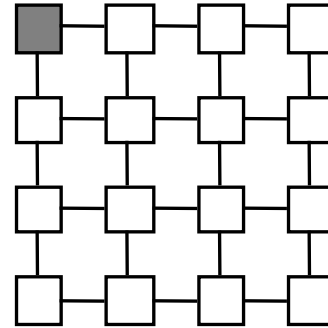

With dedicated node

Disadvantages?

Load allocation

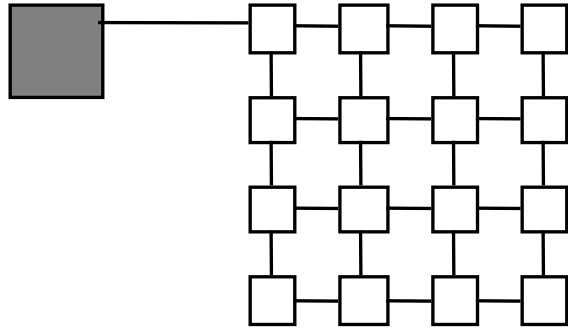

With front-end node

Load allocation

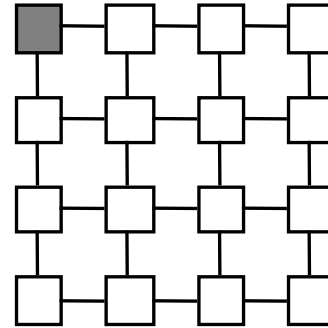

With dedicated node

## Disadvantages of central load distribution

- Aging of global information
- Danger of bottleneck
- Failure problem
- Locality of load distribution activities
- Lacking parallelism

- All nodes run identical agents that pursue a balanced load cooperatively.
- *Heuristic distributed* algorithms are applied (due to the incompleteness of the available information).
- Interplay of agents is governed by a protocol.

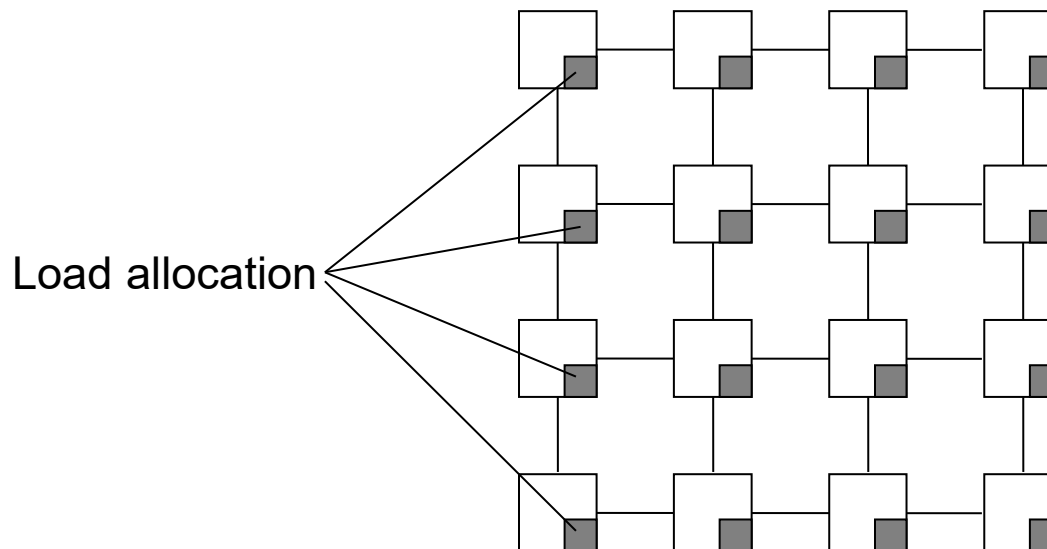



# Reference models for load distribution (Example 3x3-mesh)

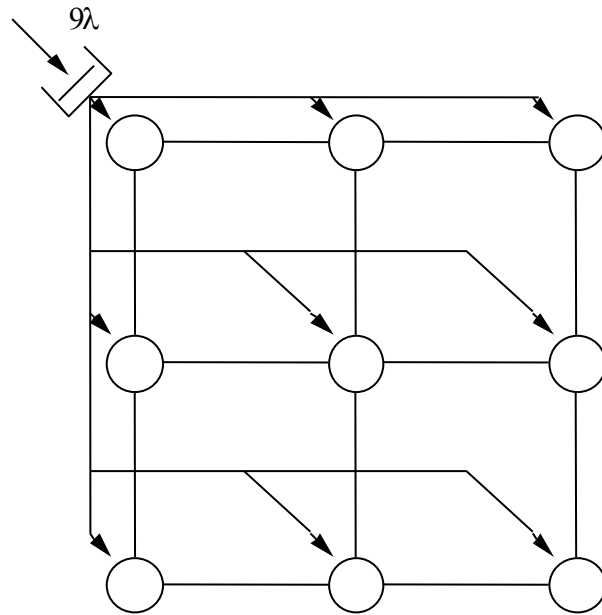

M|M|9-System

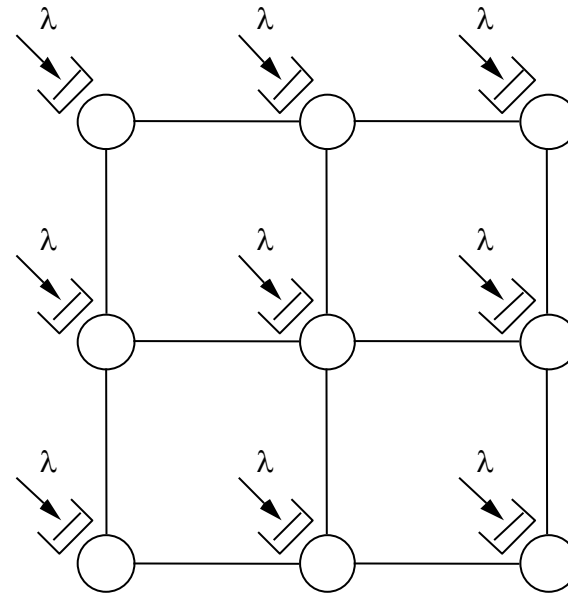

9 M|M|1-Systems

- Multiprocessor systems with shared memory and central ready list exactly correspond to M|M|n models, which is why a balanced load will develop on its own.
- Multicomputer systems rather correspond to a collection of M|M|1 systems with independent local arrival streams.

# Triggering load balancing

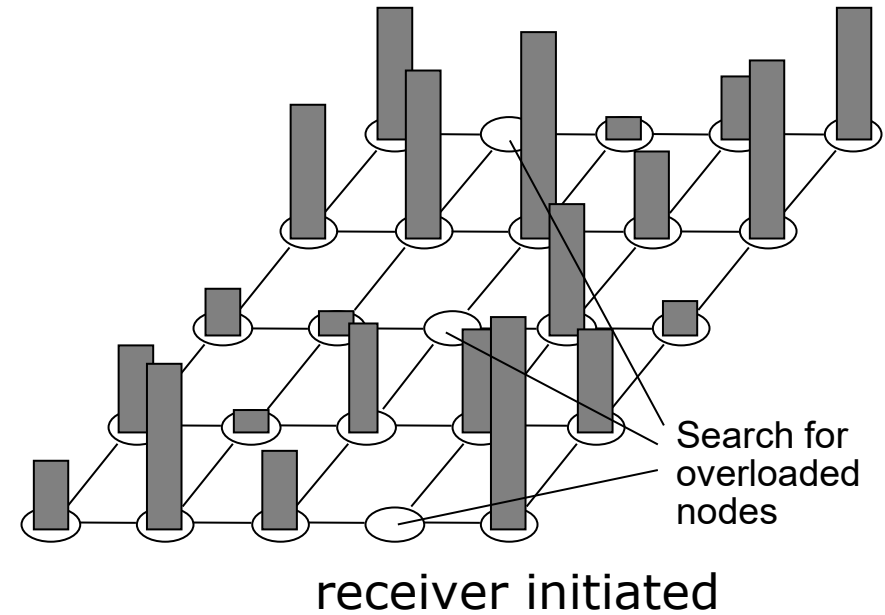
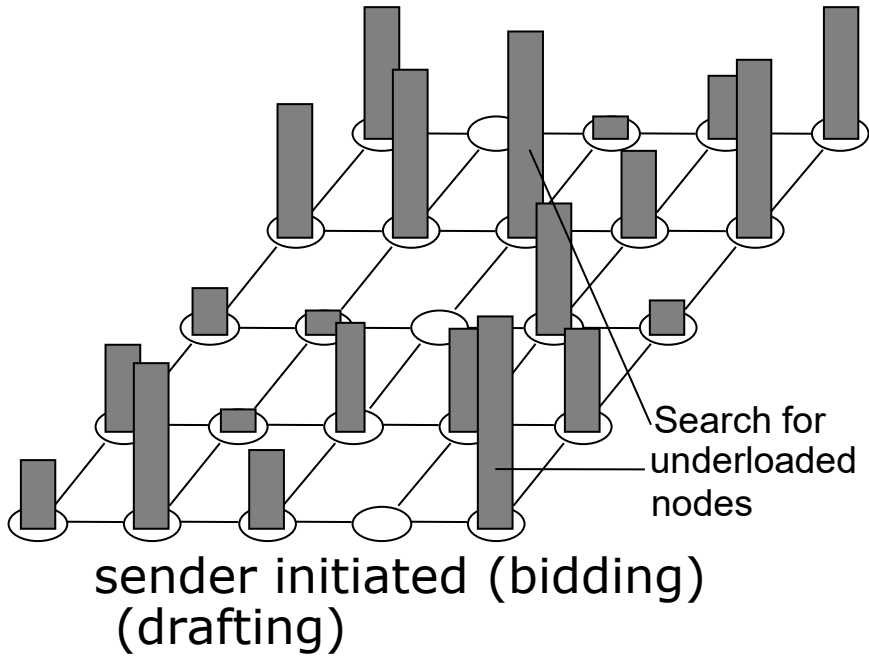

***Which is better?***

# Triggering load balancing

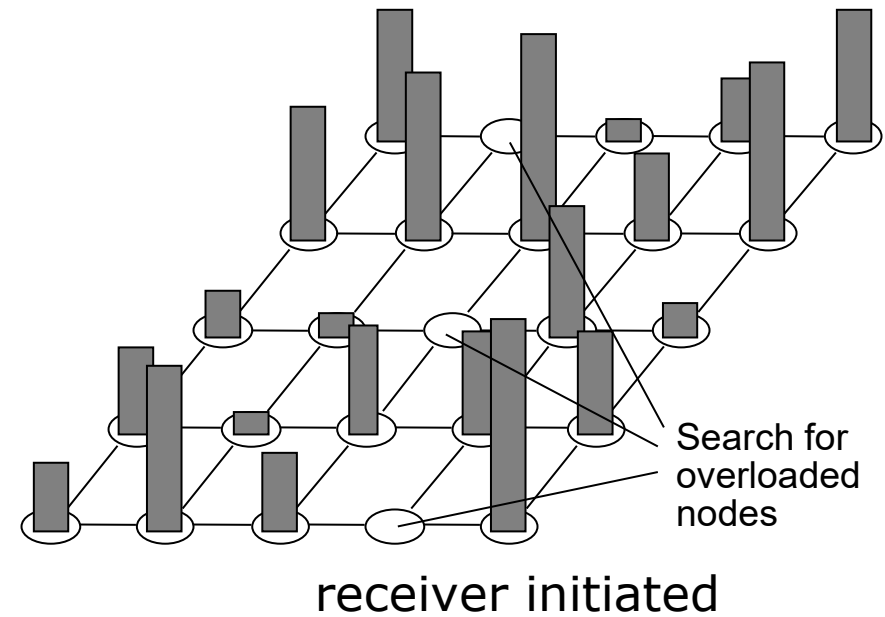
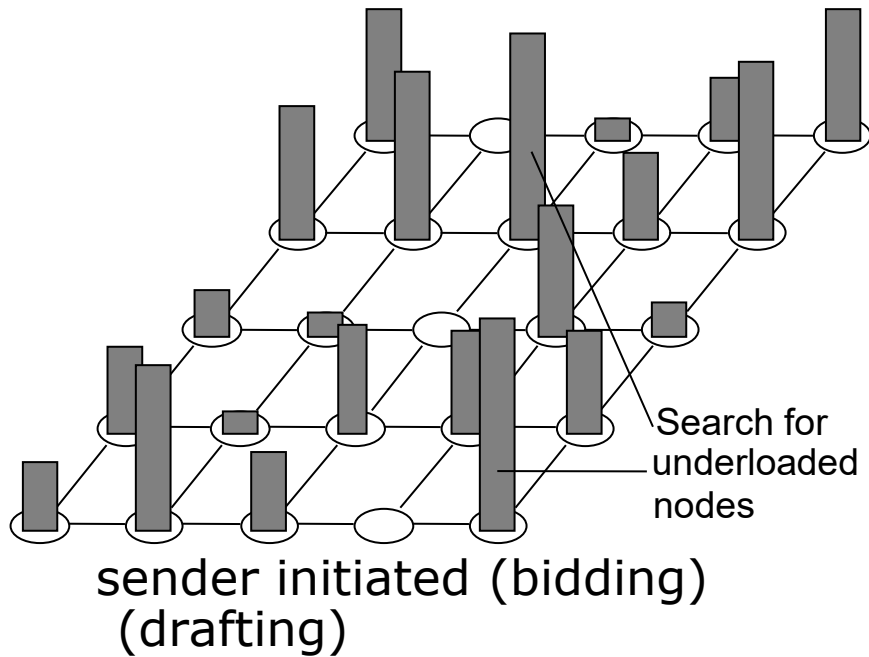

## ***Which is better?***

At high load the receiver initiation is better, at low loads the sender initiation („few select from many“)

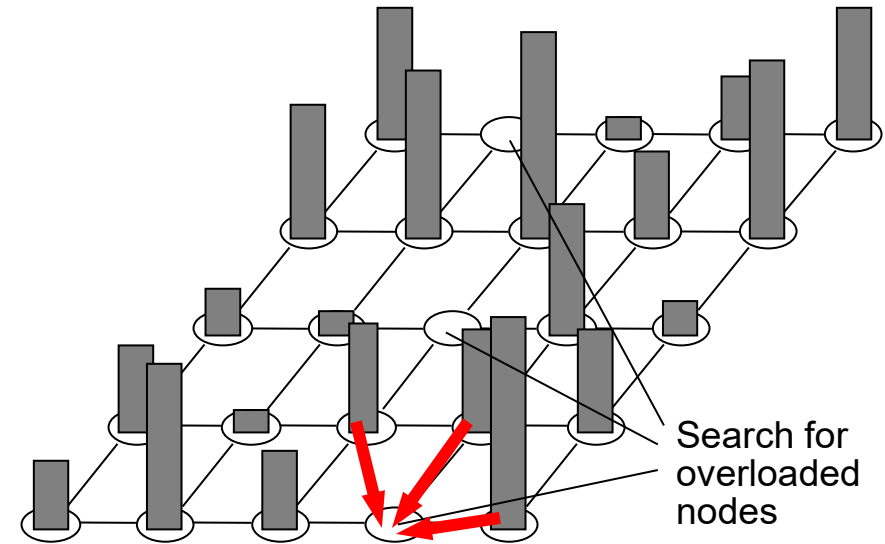
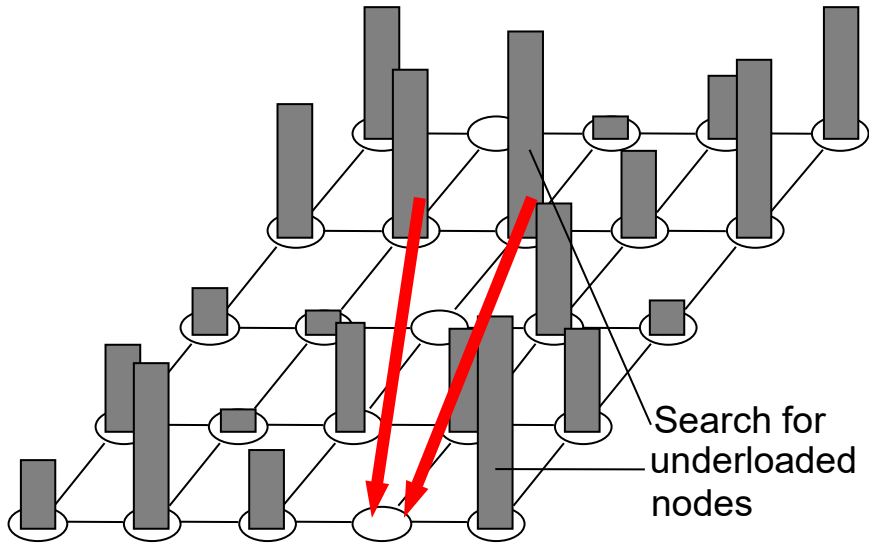

## Global Transfer

Load balancing between arbitrary nodes

## Local Transfer

Load balancing between neighbors only

***Which is better?***

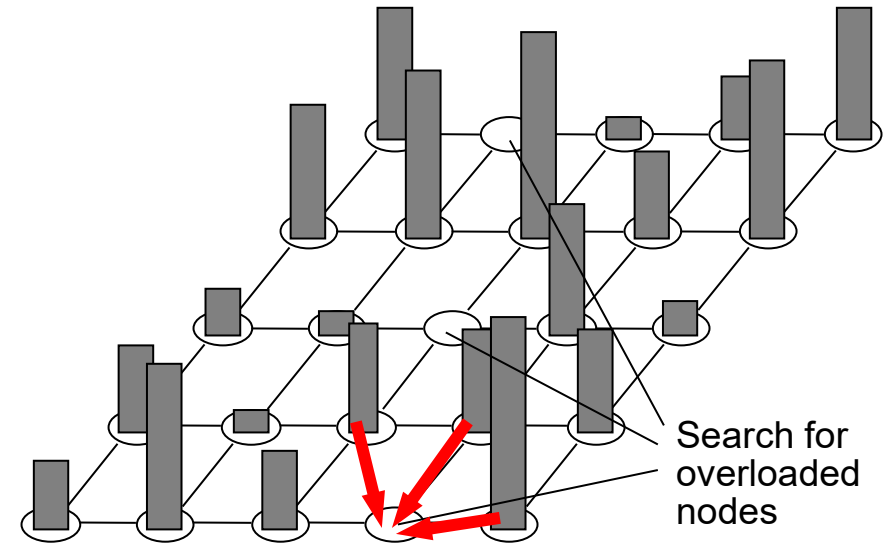
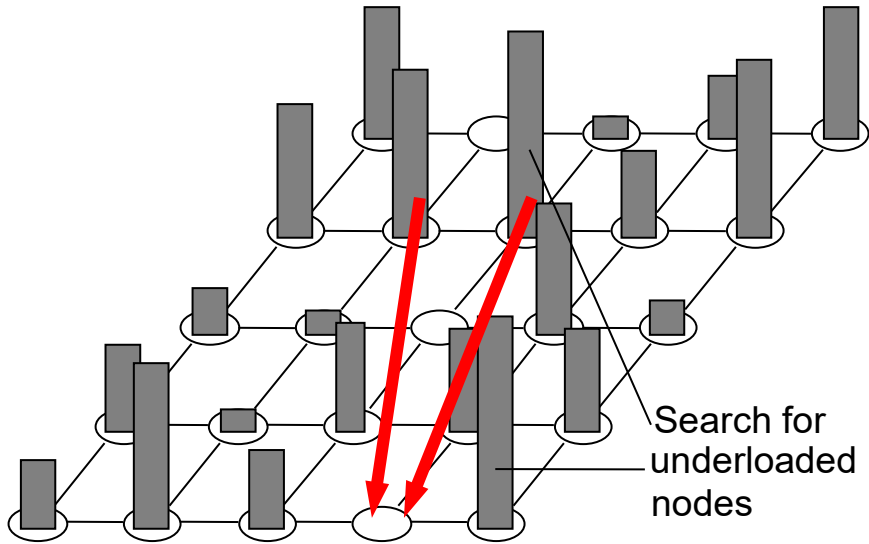

## Global Transfer

Load balancing between arbitrary nodes

## Local Transfer

Load balancing between neighbors only

**Which is better?** Better distribution vs. knowledge needed.

## Information problem

- The more accurate the knowledge of a node about the load situation of all other nodes, the better the decisions that are made cooperatively.
- Dissemination and acquisition of information means significant overhead that may destroy the benefit of load balancing.

## When to send load information messages?

## Information problem

- The more accurate the knowledge of a node about the load situation of all other nodes, the better the decisions that are made cooperatively.
- Dissemination and acquisition of information means significant overhead that may destroy the benefit of load balancing.

## When to send load information messages

- *Periodic* messages
  - Problem of proper selection of period
- *Message on load change*
  - Reduces number of messages sent
- *Message on request*
  - Information needs only be sent when demanded
  - Reduces the number of sent messages (if demanded not too often) but means additional delay when needed

- *Broadcast-based solutions (all-to-all-broadcast)*
  - High overhead:  $O(n^2)$  messages
- *Random selection*
  - Information diffuses as a stochastic process through the network.
  - Reduces number of messages, but slows down the dissemination process.
- *Broker*
  - Collects offers and requests and helps to find a match
  - Nodes send their own load state periodically or at changes
  - Nodes can request load information about other nodes from Broker



## Example of random selection:

- Each node maintains a state vector  $Z$  of length  $k < n$ , in which the own state  $Z(0)$  and states of other  $k-1$  randomly selected nodes are stored.
- Periodically each node performs the following actions:
  - 1. Update own state  $Z(0)$
  - 2. Select processor  $r$  randomly ( $1 \leq r \leq n$ )
  - 3. Send first half of state vector  $Z$  to node  $r$
- Upon reception of a half state vector  $Z_r$  merge the first half of the own vector with the received half according to the following rule:

$$Z(2i) \leftarrow Z(i) \quad , \quad 1 \leq i \leq k / 2 - 1$$

$$Z(2i + 1) \leftarrow Z_r(i) \quad , \quad 0 \leq i \leq k / 2 - 1$$

# Example of random selection

	0	1	2	3	4	5
node	2	7	13	5	9	6
state	3	2	1	4	3	8

**Node 2**

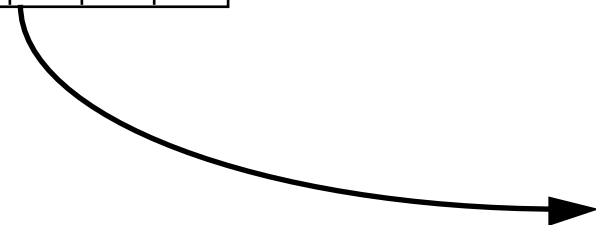

	0	1	2	3	4	5
node	9	11	6	3	4	7
state	2	3	5	1	2	2

**Node 9**

# Example of random selection

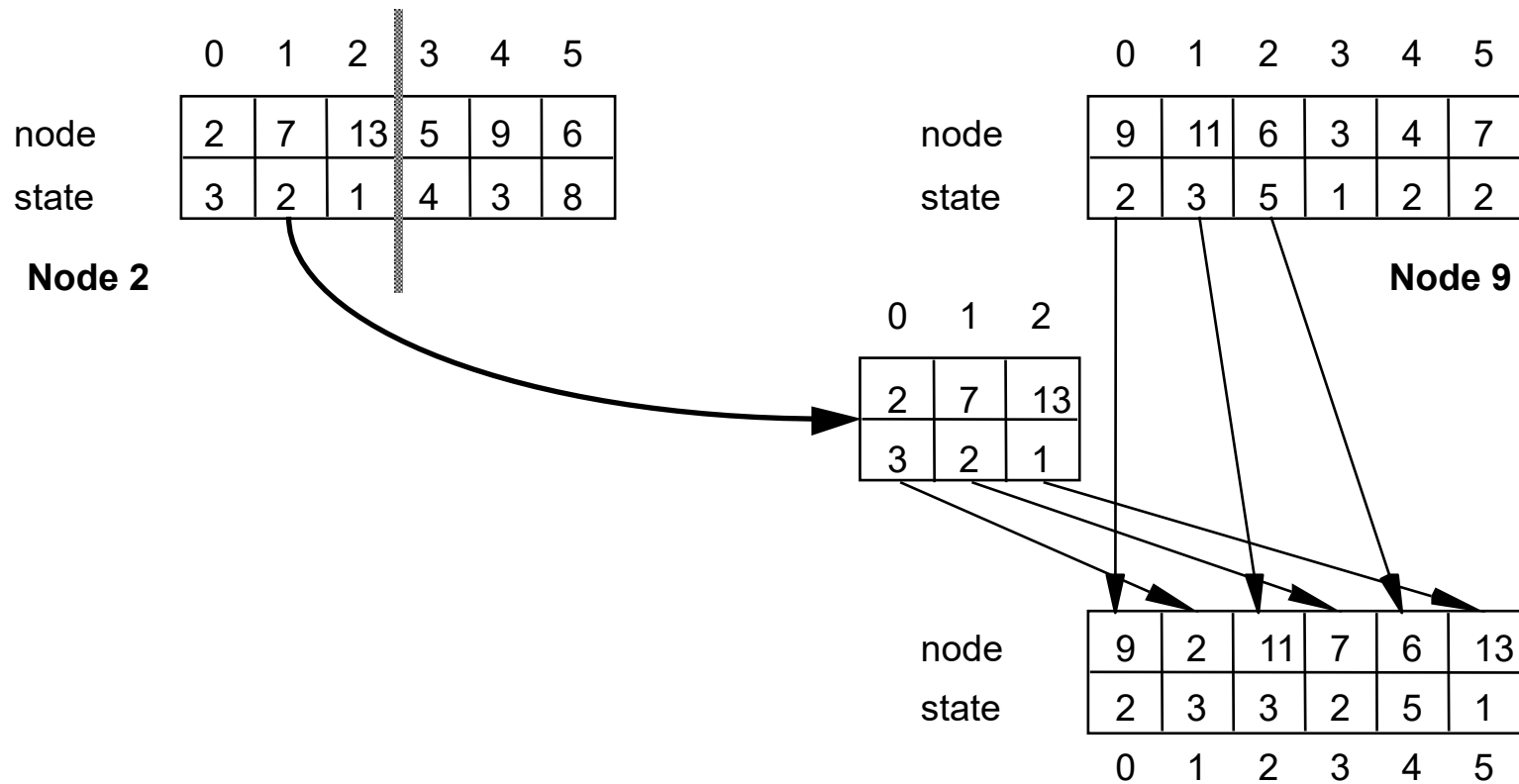

## 9.2 Microeconomic approaches

- Microeconomic approaches try to solve the allocation problem using market mechanisms.
- Resources (computational- and transmission capacity) are considered as scarce goods on a electronic market place.
- Applications or threads are buyers or consumers of these resources.
- Bids are managed by performing auctions.
- After specific rules a buyer is awarded a contract.
- Both sides (buyer and seller) try to maximize their individual utility function.

- Different kinds of interest (necessity, utility) of a requester for a resource can be modeled.
- Often, usage of resources has to be paid for anyway (accounting).
- Scarcity leads to price increase and to demand decrease.
  - Overload prevention
  - Hot-Spot avoidance
- Idle capacities result in decrease of prices:
  - Demand is stimulated
- Automatic adaptation
- Good theoretic foundation (microeconomics, game theory)

# 9.2.1 Auctions

forms of auctions?

# 9.2.1 Auctions

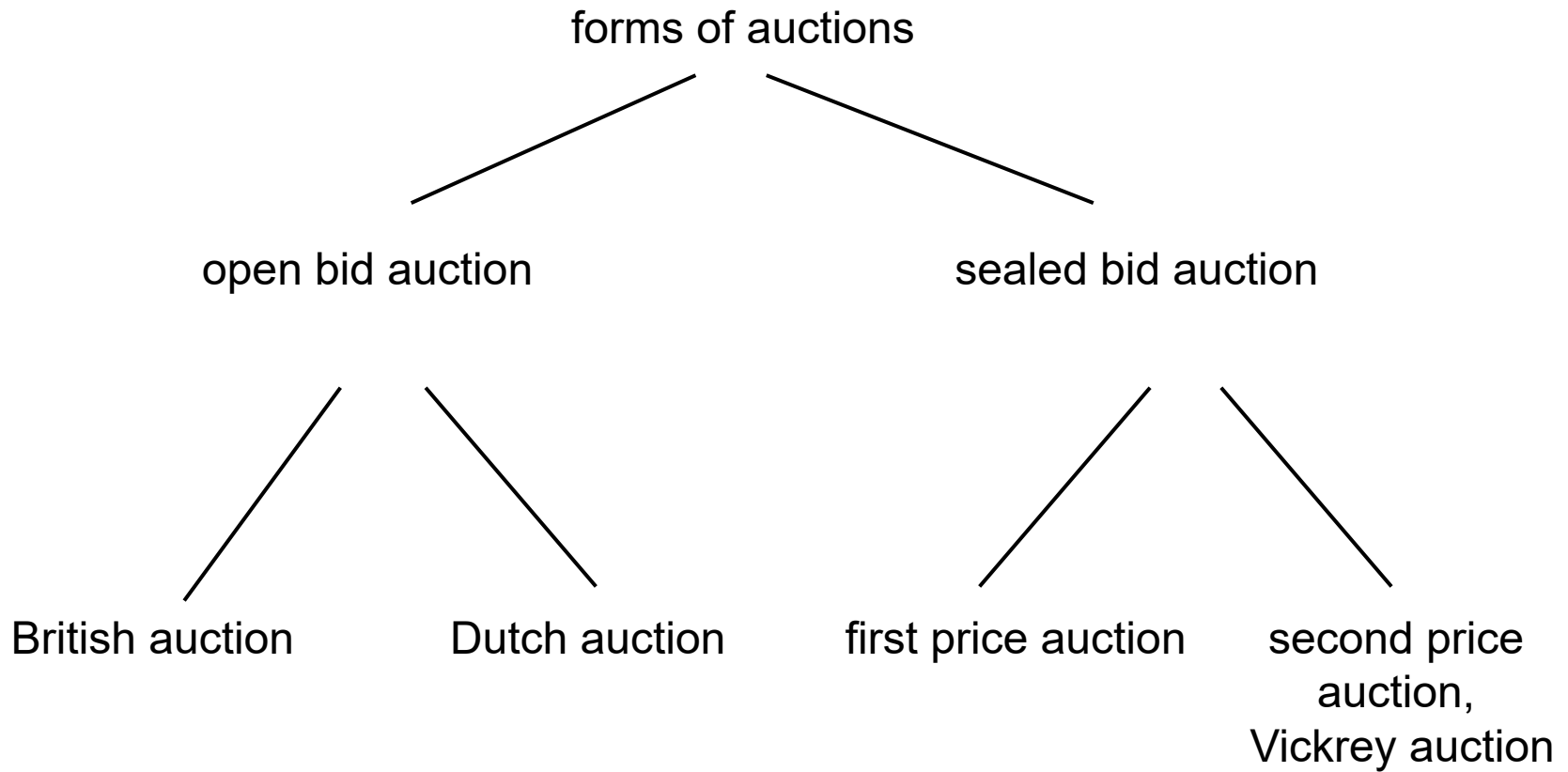

# British Auction (Ascending Bid)

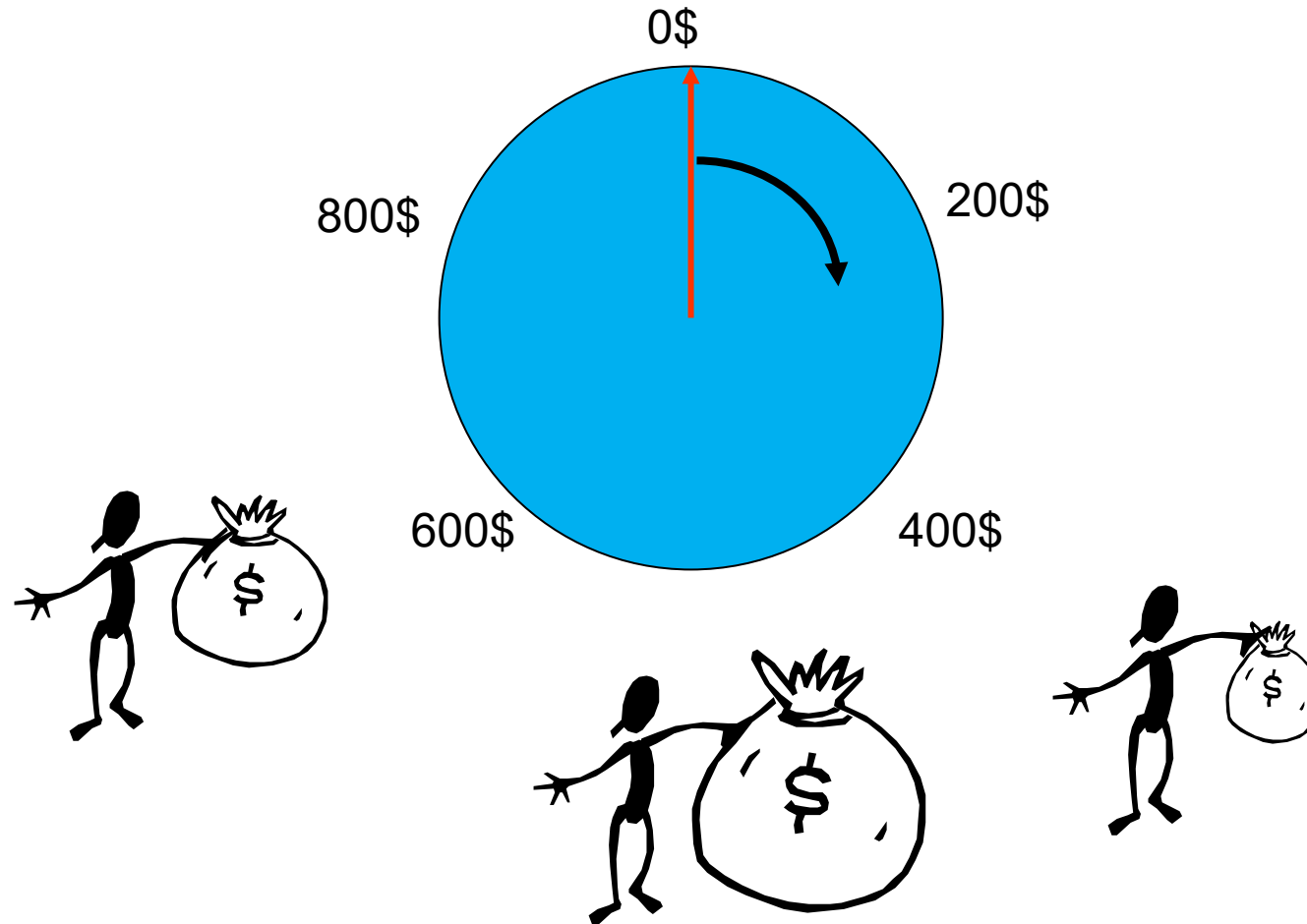

Usual in auction houses: Sotheby's, Christie's



# Dutch Auction (Descending Bid)

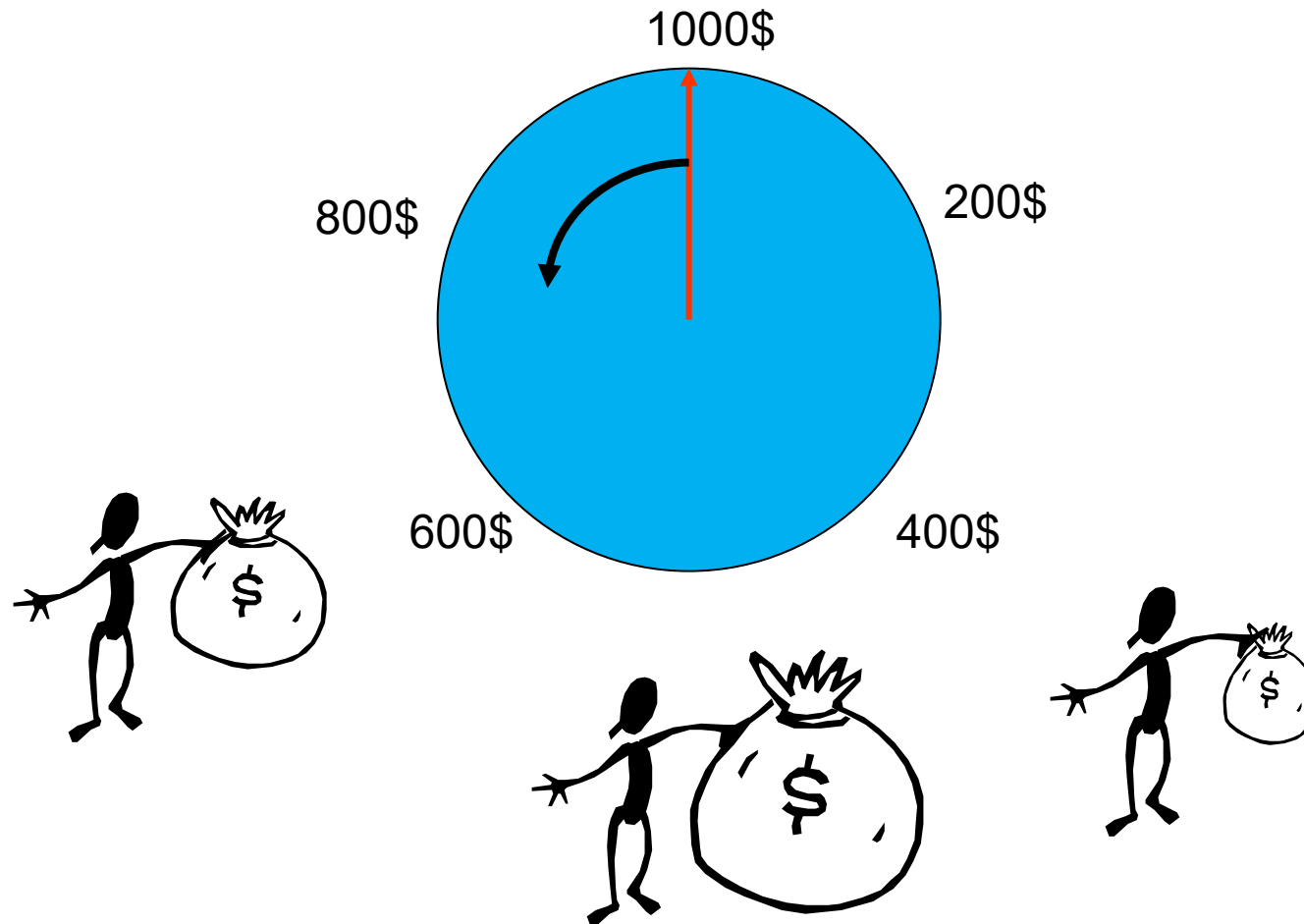

Usual at central markets (e.g. Dutch flower market)

# First Price Sealed Bid Auction

**Step 1:  
Submitting bids**

**Auctioneer**

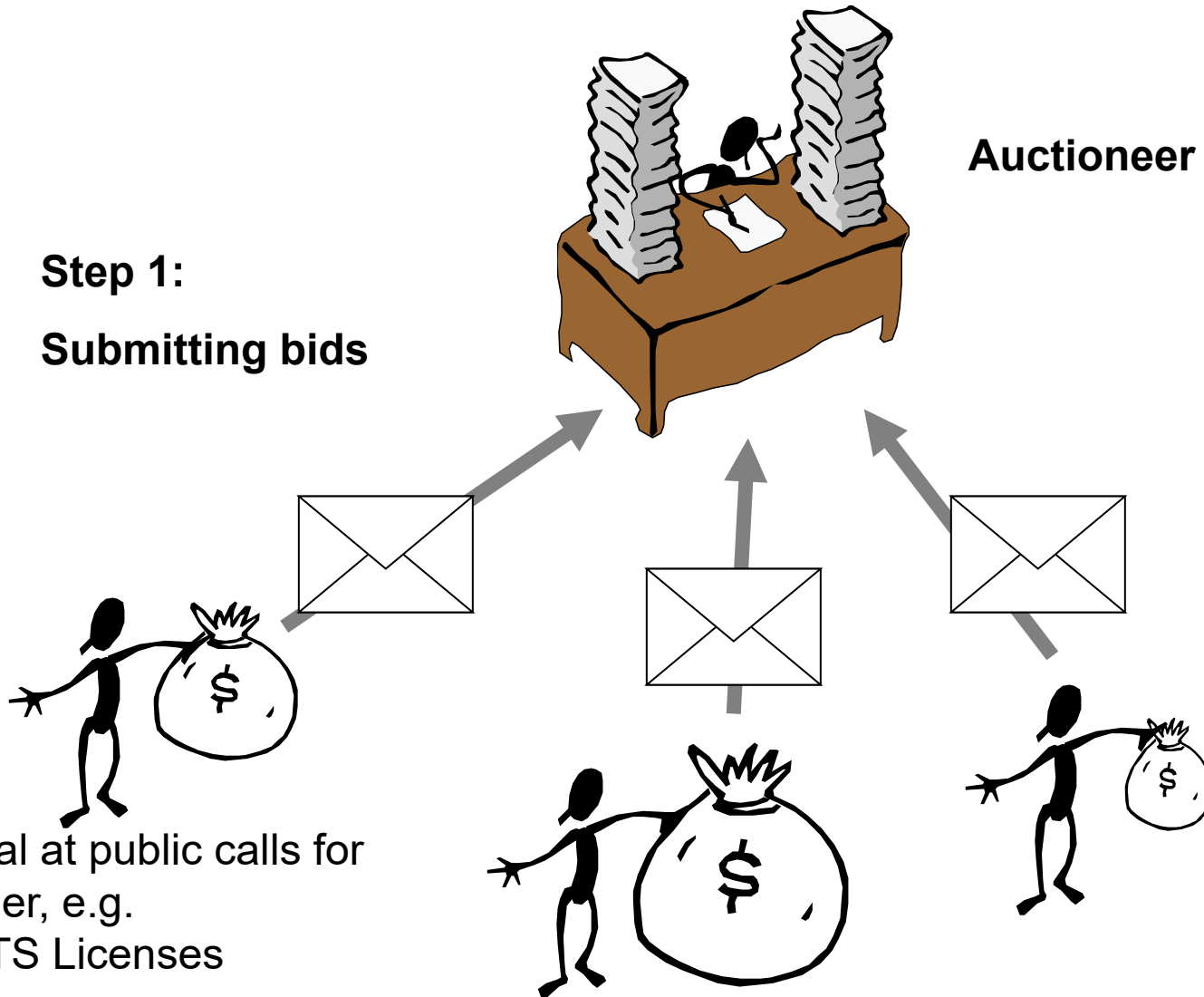

Usual at public calls for tender, e.g. UMTS Licenses

# First Price Sealed Bid Auction

**Step 2:**  
**Selection of best bid**



**Auctioneer**

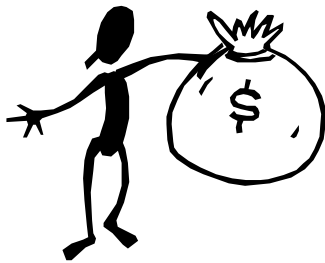

# First Price Sealed Bid Auction

Step 3:  
award



Auctioneer

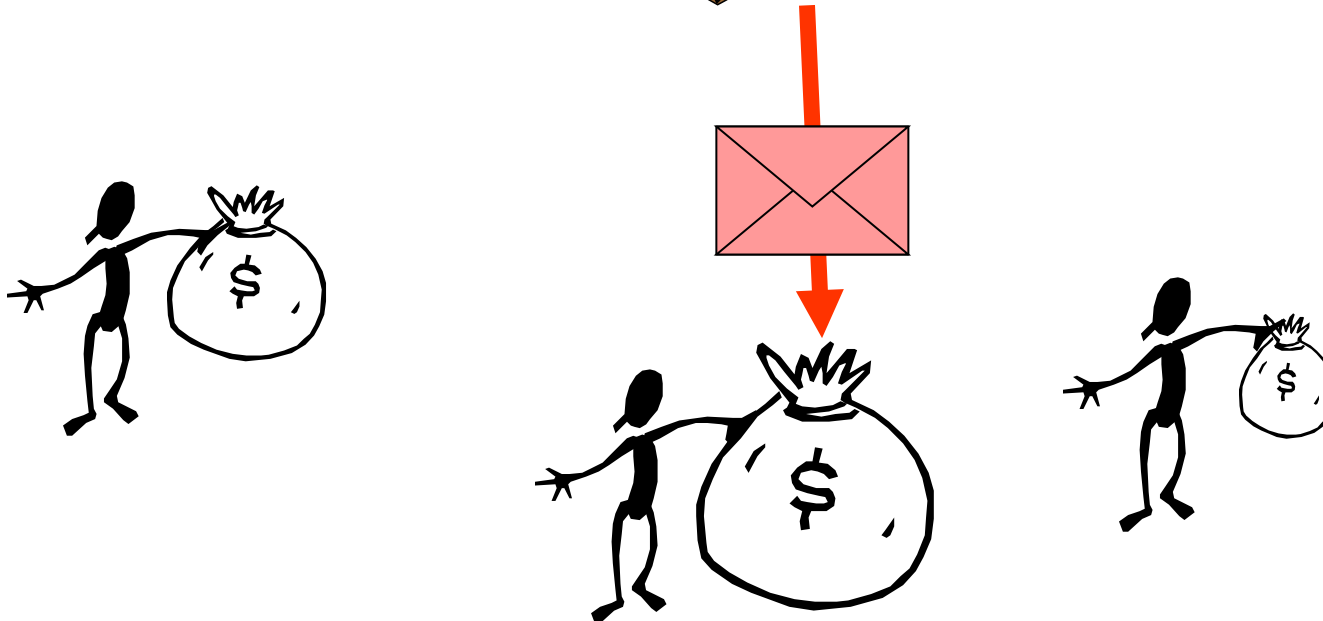

# Variant: Second Price Sealed Bid Auction

Step 3:  
award



Auctioneer

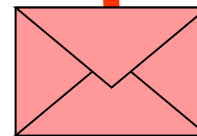
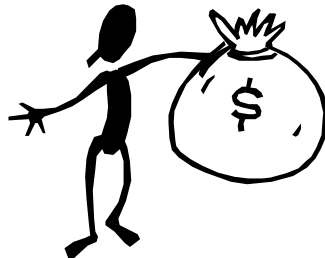

Winner pays only the  
Amount of second highest bid  
(Vickrey, Nobel prize 1996)



# Variant: Second Price Sealed Bid Auction

Winner pays only the  
Amount of second highest bid

Why would an auctioneer use this?

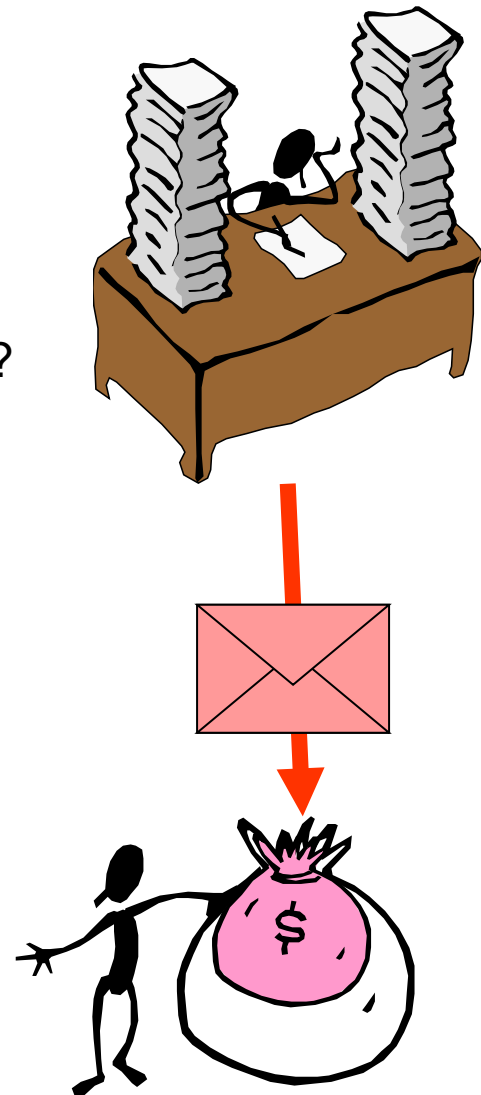

**Auctioneer**

# Theoretic result

- Under some assumptions (individual preferences, symmetric bidder,...) the following theorem holds:
- **Revenue Equivalence Theorem (Vickrey):**  
All four forms of auctions lead to the same expected (ex ante) revenue.  
  
„Ex ante“ means: on the basis of information available before the auction.

## Other Variants / Aspects

- Double-sided auctions: many seller - many buyer (stock exchange)
- Public sale of bundles of goods/resources (bundle bidding, combinatoric auctions)
- Continuing auctions (no punctual auctions, but continuous submission of bids)
- Volume discount auction (discount for larger amounts)
- Multiattribute auctions (besides the price other attributes (timeliness, reliability, QoS) have to be considered)



# 9.2.2 Example: Processes in a distributed system

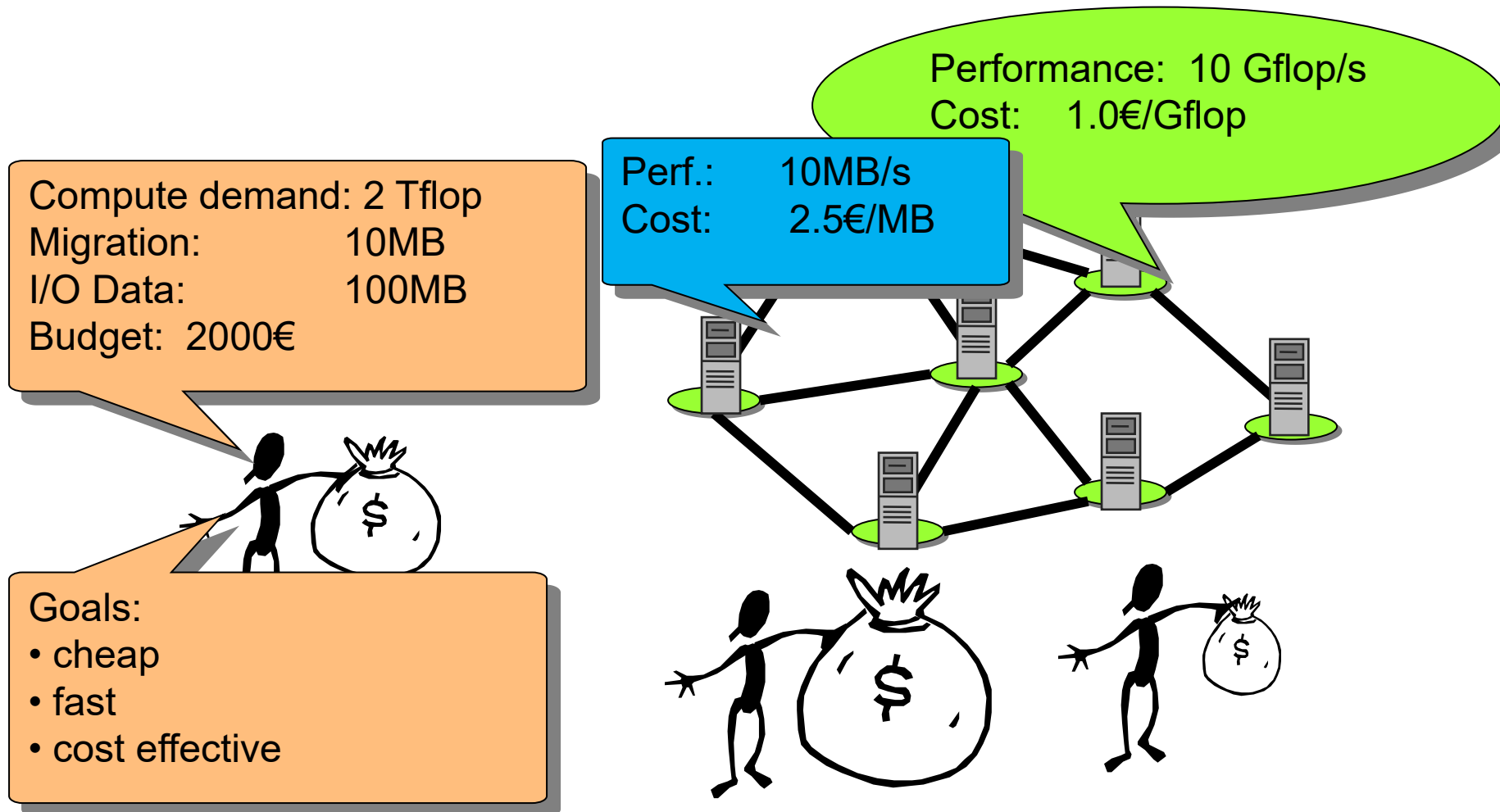

# Model Framework

Let be  $GP = (P, E_p)$  the processor graph with

- $n$  Number of processors  $|P|$
- $d_{kl}$  Distance between processor  $P_k$  and  $P_l$ , (transmission time per data unit)
- $\mu_k$  processing speed of processor  $P_k$  (instructions / time)

Let  $T$  be the (dynamic) set of processes with

- $m$  number of processes  $|T|$
- $\beta_i$  compute demand of process  $T_i$  (number of instructions)
- $b_i$  size of description of process  $T_i$   
(number of data units to be migrated)
- $e_i$  size of result of process  $T_i$   
(number of data units to be transmitted to the location of origin)

# Microeconomic Model

- At its creation, each process gets some amount of money  $B_i$ , its *Budget*.
- Each requested service (computation, transmission) needs to be paid for.
- Example:
  - $T_i$  needs  $\beta_i$  Instructions:
    - for its execution on processor  $P_k$  it must buy  $\beta_i / \mu_k$  CPU seconds.
- The processors announce their current prices at their locations.
- These price lists can be seen from all neighboring nodes.

# Behavior of processes

## (1) Calculation of action space

- The action space  $A_i$  of a process  $T_i$  consists of the set of actions it can still afford, based on its current budget
- Formally:
  - action space = set of pairs  $(k, C_k)$  with  $C_k < B$ .
- $C_k$  are the costs of a service (e.g. computation) on  $P_k$ , composed of:
  - Execution cost:
    - If  $p_k$  is the current price for a CPU second on processor  $P_k$  then the execution costs are  $p_k (\beta_i / \mu_k)$
  - Migration cost:
    - If a process  $T_i$  is currently residing on processor  $P_l$ , then  $b_i$  data must be transmitted from  $P_l$  to  $P_k$ , which results in costs of  $b_i p_{lk}$  if the current transmission price is  $p_{lk}$ .
  - Cost for transmission of results to  $P_l$ :  $e_i p_{lk}$

## (2) Defining preferences (Ordering the action space)

- Depending on its preferences, each process selects from its action space the „best“ action. Different criteria or preferences are possible:

Which ones?

## (2) Defining preferences (Ordering the action space)

- Depending on its preferences, each process selects from its action space the „best“ action. Different criteria or preferences are possible:
- **Price:**
  - The cheapest action is selected.
- **Performance:**
  - The action with the shortest execution time  $S_k$  is selected:  
$$S_k := \beta_i / \mu_k + b_i d_{ik}$$
if process  $T_i$  currently resides on processor  $P_i$ .
- **Cost-effectiveness:**
  - The action with the best price-performance-ratio (PPR) is selected.
  - Since the execution time is inversely proportional to "performance", we define:  
$$PPR_k := C_k S_k$$

## (3) Submitting a bid

- A bid  $G$  consists of the price charged plus a surcharge depending on the remaining budget:
- Let  $(k, C_k)$  be the action selected by  $T_i$ :  
$$G := \text{price} + (B - C_k) a_i$$
  
with  $0 \leq a_i \leq 1$  outbid factor
- If there is more than one bid for a resource, the processor makes some appropriate choice.
- The process  $T_j$ , that is awarded the contract, assumes that it might have bid too much and therefore sets:  $a_j := a_j - d_j$  ( $d_j > 0$ ).
- Processes  $T_i$ , that have been outbid conclude that they have bid too little and set:  $a_i := a_i + d_i$  ( $d_i > 0$ ).

# Example:

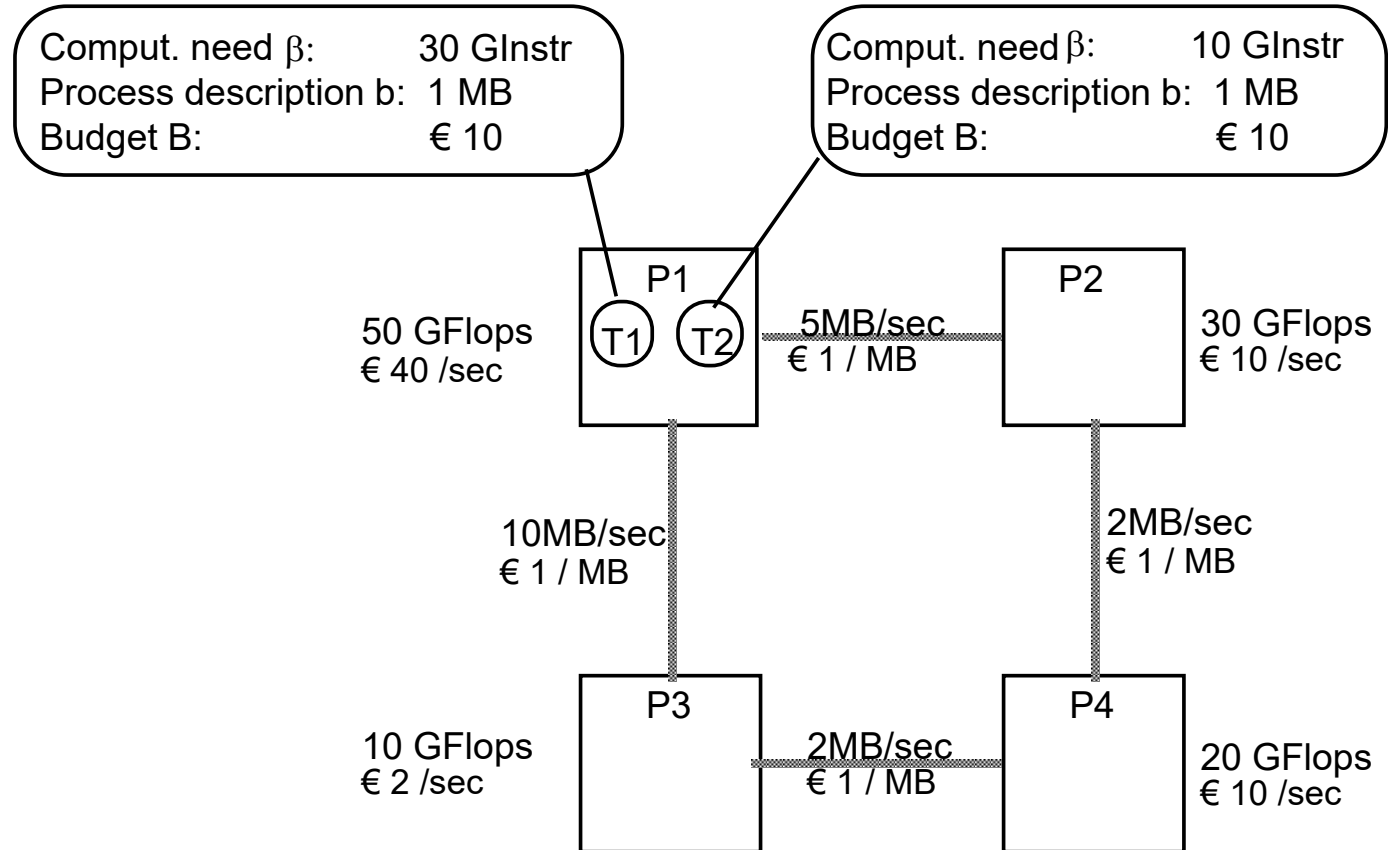



## Example (continued)

- Calculation of action spaces (grey means „not feasible“, i.e. not within budget constraints)

<b>Actions of T1</b>	<b>P1</b>	<b>P2</b>	<b>P3</b>
Price			
Performance			
Cost-effectiveness			

<b>Actions of T2</b>	<b>P1</b>	<b>P2</b>	<b>P3</b>
Price			
Performance			
Cost-effectiveness			

## Example (continued)

- Calculation of action spaces (grey means „not feasible“, i.e. not within budget constraints)

<b>Actions of T1</b>	<b>P1</b>	<b>P2</b>	<b>P3</b>
Price	24 €	11 €	7 €
Performance	0.6 sec	1.2 sec	3.1 sec
Cost-effectiveness	14.4 € sec	13.2 € sec	21.7 € sec

<b>Actions of T2</b>	<b>P1</b>	<b>P2</b>	<b>P3</b>
Price	8 €	4.33 €	3 €
Performance	0.2 sec	0.533 sec	1.1 sec
Cost-effectiveness	1.6 € sec	2.31 € sec	3.3 € sec

# Behavior of Processors

## 1 Perform Auction

- Based on current prices the processes submit their bids.
- If there is more than one bid, the processor starts an auction aiming at selecting the most favorable bid.
- Two approaches for selection:
  - Sealed bid
  - Dutch auction

## 2 Adapt Prices

- After the auction the new price is determined as that at which the contract was signed.

## 3 Advertise

- The processors send their new pricelists to neighboring nodes.

## Maximum Unit price

- A bid consists of a demanded service  $L_i$  and an offered amount of money  $G_i$ :
- The bid with  $\max\{G_i / L_i\}$  wins.
- That leads to the following algorithm (sealed bid auction):

```
Price ← initial price
while not (bid accepted) do
    notify prices
    collect bids
    if number of bids submitted > 0
        then contract for  $\max\{G_i/L_i\}$ 
    else Price ← Price - deduction
end while
```

With the Dutch Auction the initial (high) price is decremented (and if necessary incremented again) until exactly one bid is remaining (Dutch auction):

```
Price ← initial price
while not (bid accepted) do
    notify prices
    collect bids
    case (number of submitted bids)
        0 : price ← price - delta
        1: accept bid
        otherwise: price ← price + delta
    end case
end while
```

Simulations for a homogeneous 3x3-mesh-connected system and a dynamic arrival stream of processes with exponentially distributed service times yields the following results:

- Concerning response time, no significant differences for the preference- and auction variants.
- Migration behavior:
  - For price preference relatively high, for performance preference relatively low migration rate.
- Budget:
  - If all processes have the same budget then short processes are relatively „rich“, long processes relatively „poor“.
  - Short processes can outbid long processes and finish earlier.
  - This approximates the „shortest job next“ strategy, that generally minimizes the average response time.
- Dutch Auction is slightly better than Sealed Bid Auction, but has a higher overhead due to additional communication rounds.

## 9.3 Physical Model

Many programs share the machine in space and time.  
(Dynamic Multiprogramming)

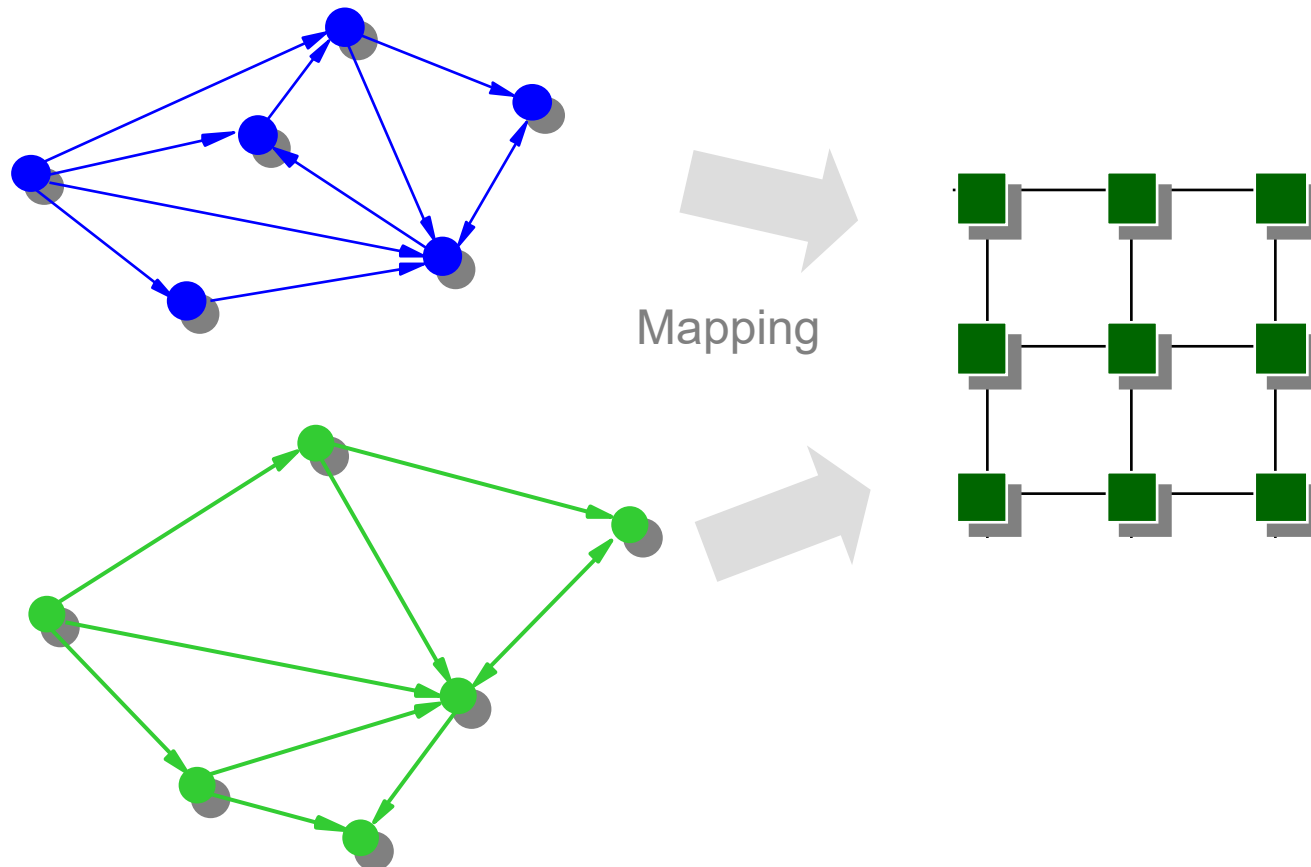

# Model framework

Parallel computer given as a Processor connection graph  $G^P = (P, E_P)$  with

- $P$  Processors (nodes)
- $E^P \subseteq P \times P$  Interprocessor links (edges)
- $\delta_{kl}$  Time to transmit a data packet over a link  $(k,l)$  (edge weight)
- $\mu_k$  Processing speed of processor  $k$  (*node weight*)

The set of the parallel threads is modeled as a task interaction graph  $G^T = (T, E_T)$  with

- $T$  Set of threads (nodes, vertices)
- $E^T \subseteq T \times T$  Set of communication relations (edges)
- $\alpha_{ij}$  Communication intensity
- $\beta_i$  Processing demand of thread  $i$  (# Instructions)
- $b_i$  Size of thread description  $i$   
(Amount of data to be transferred when migrating)



Spatial and temporal sharing among several programs.

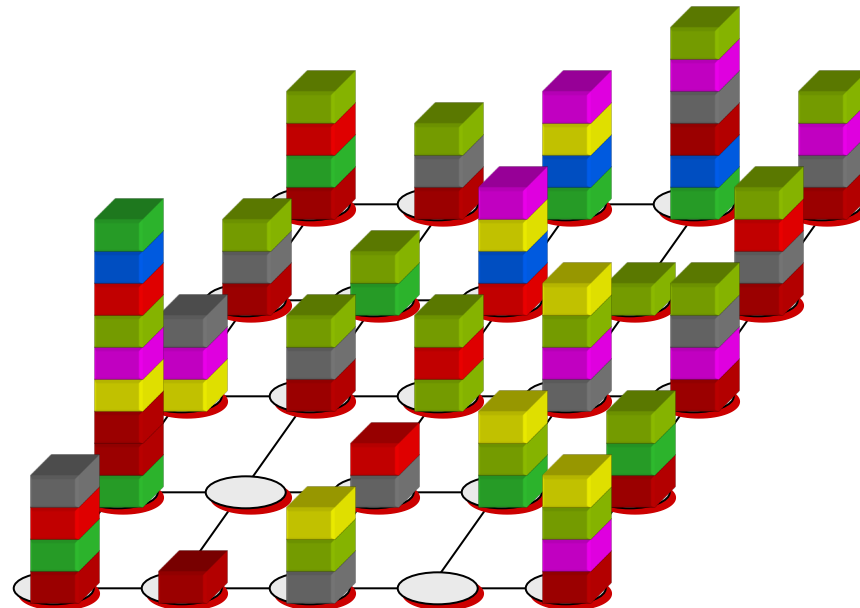

All processors have roughly the same load.

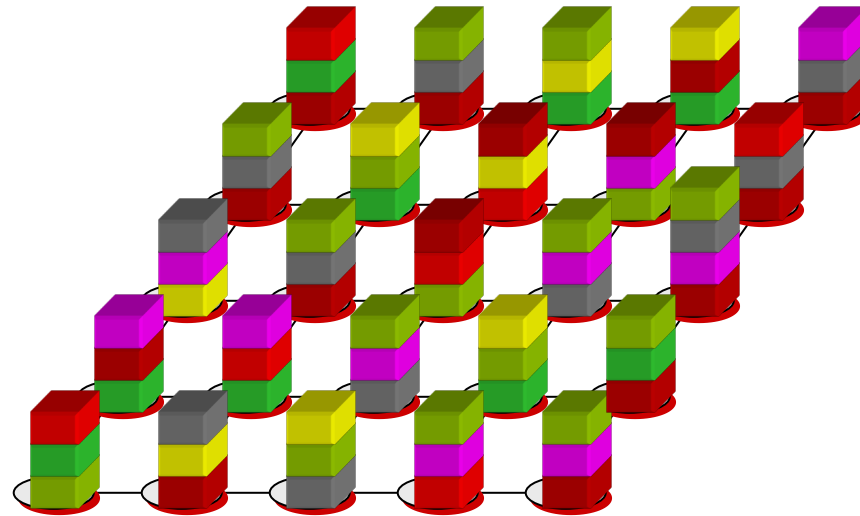

Threads of the same program communicate with each other.

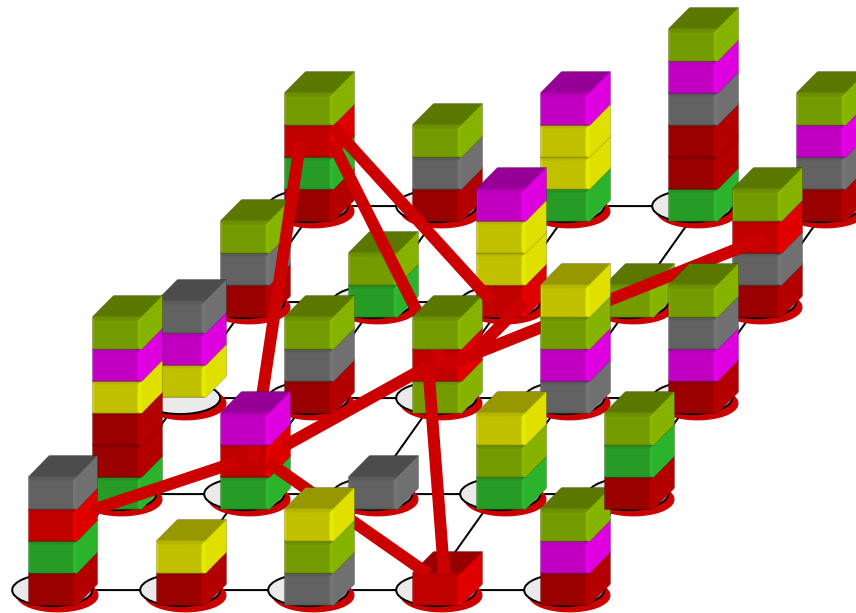

Here the communication cost are 0, but the red program is no longer executed in parallel.

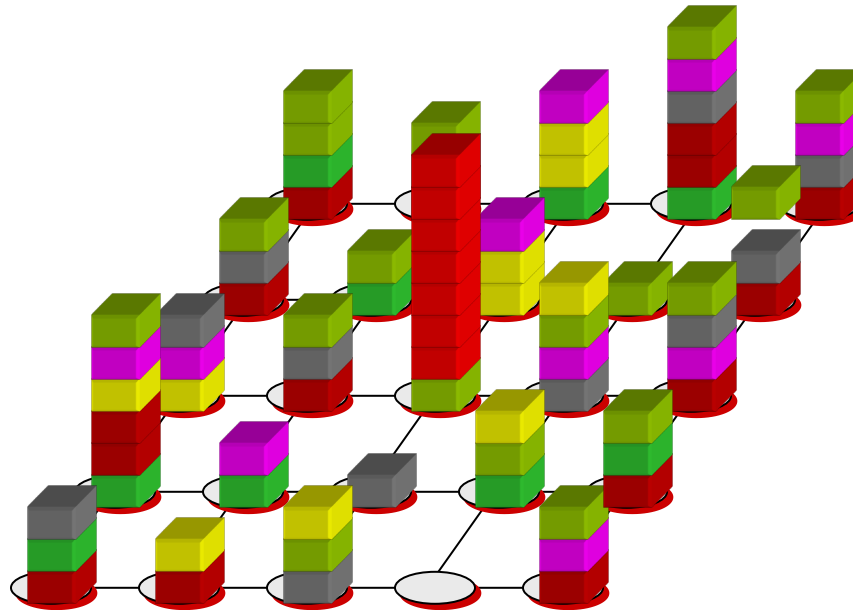

Communication cost better now than before, and nevertheless full parallelism.

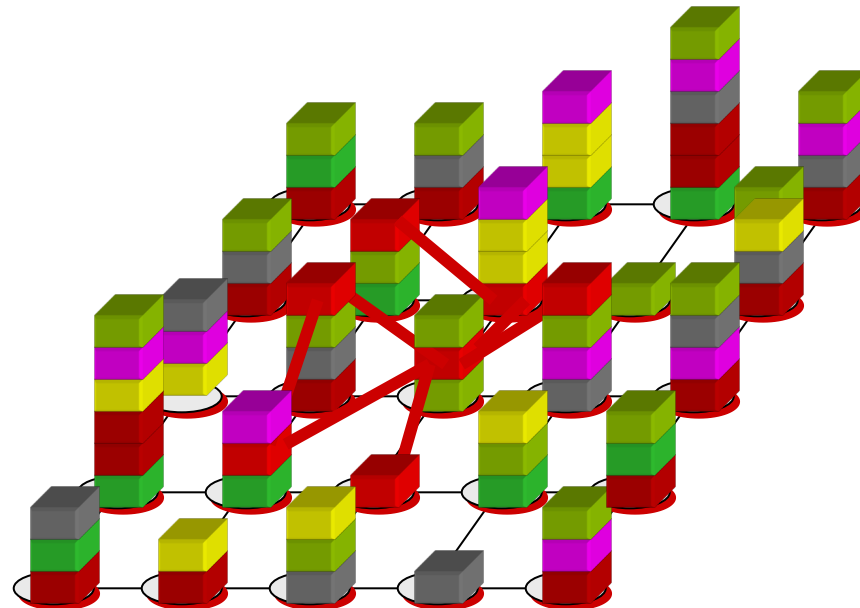

New program: where?

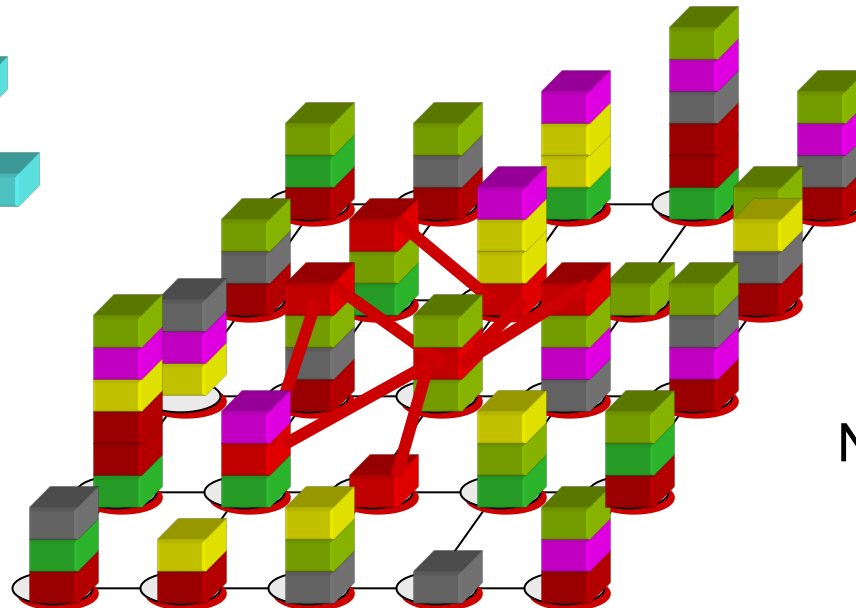
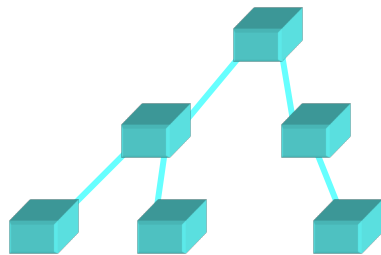

New threads: where?



Changing Communication behavior:  
Remap? (=Migrate?)

- Balanced load
- Low communication cost
- Exploit potential parallelism
- Consider dynamic behavior
- Avoid unnecessary migrations
- Stability

How to pursue contradictory goals simultaneously?

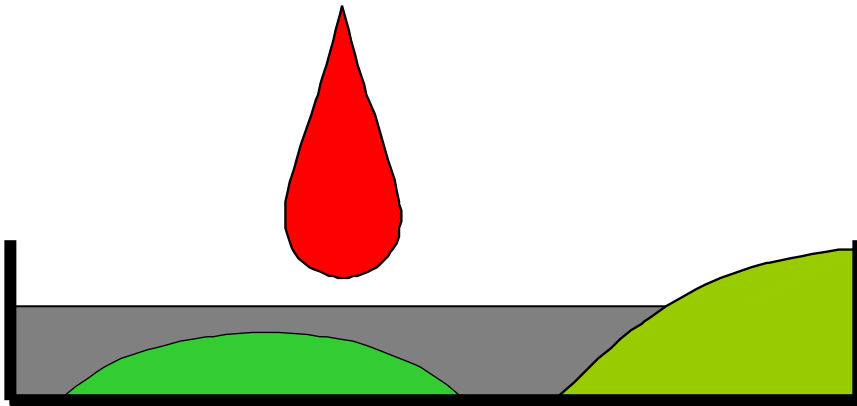

Receptacle with nonmixable fluids of different viscosity.

New fluid is added.

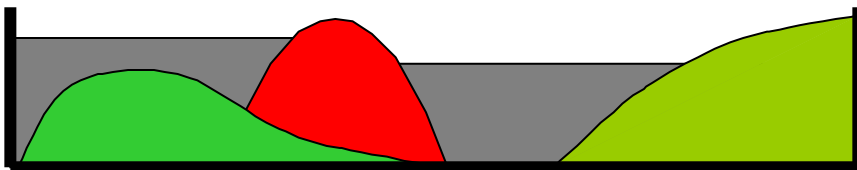

After some time an energetic equilibrium is reached.



<b>thread</b>	<b>particle</b>
<b>program</b>	<b>viscous fluid</b>
<b>processor</b>	<b>coordinate</b>
<b>load balance</b>	<b>gravitation</b>
<b>communication</b>	<b>bonding forces</b>
<b>migration</b>	<b>friction</b>

## Load balancing ( gravitation)

Force proportional to load difference

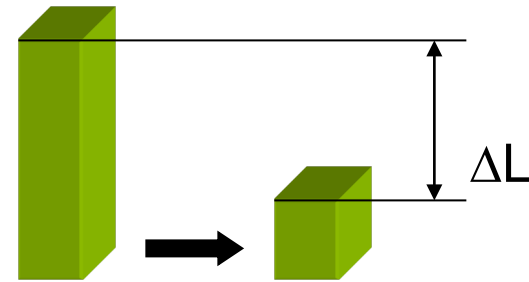

## Communication cost (bonding force)

Force proportional to communication intensity (rubber band)

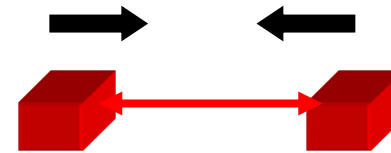

## Migration cost (frictional resistance)

proportional to the amount of data to be transmitted



**Forces are weighted with coefficients („nature constants“) and added along the edges.**

# Example

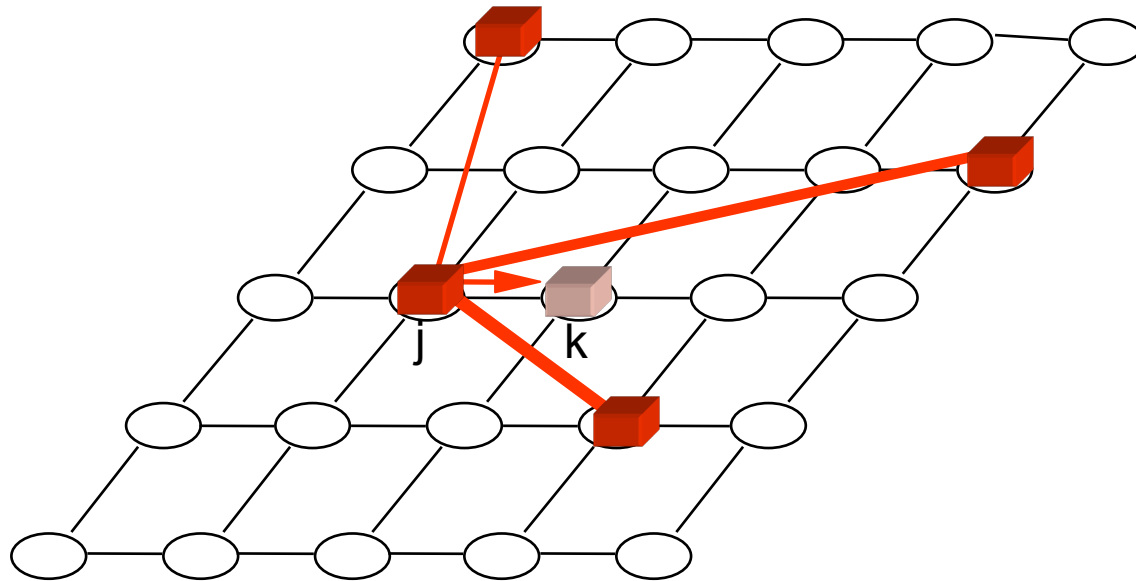

communication links act as rubber bands

$$R_{res}^{j \rightarrow k}(t_i) := c_{lb} f_{lb}^{j \rightarrow k}(t_i) + c_{com} f_{com}^{j \rightarrow k}(t_i) + c_{mig} f_{mig}^{j \rightarrow k}(t_i)$$

- = Loadbalancing
- + Communication
- + Migration

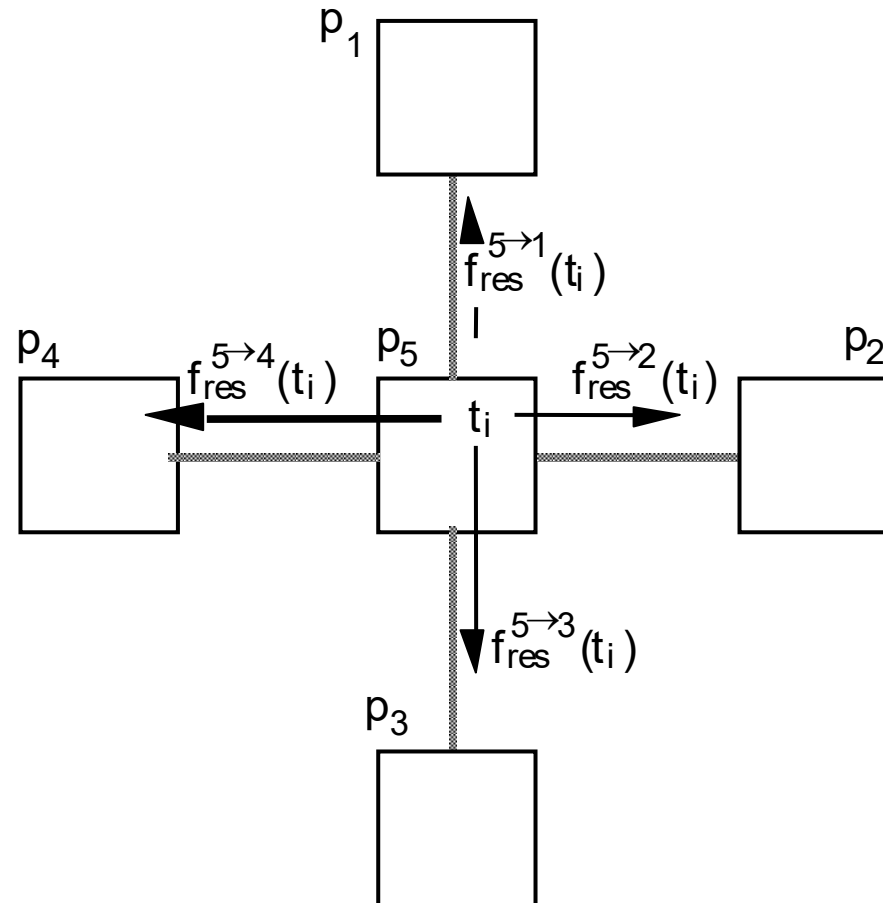

# Results (of simulation)

## Load balance

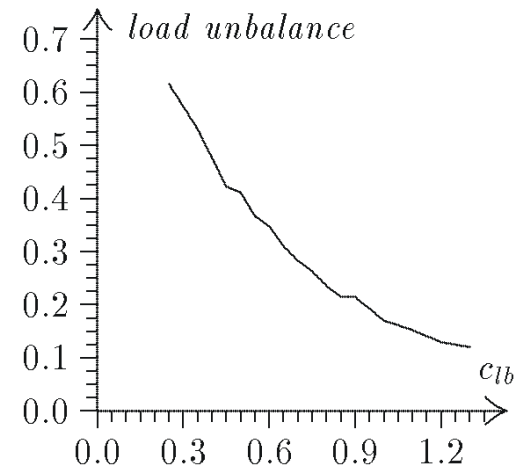
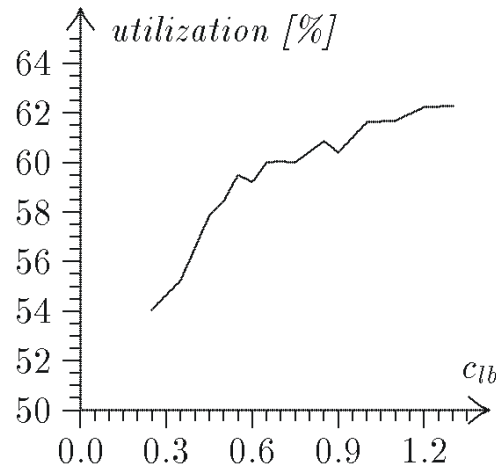
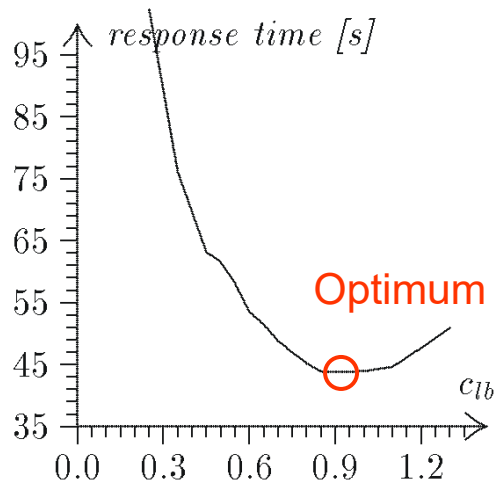

## Communication cost

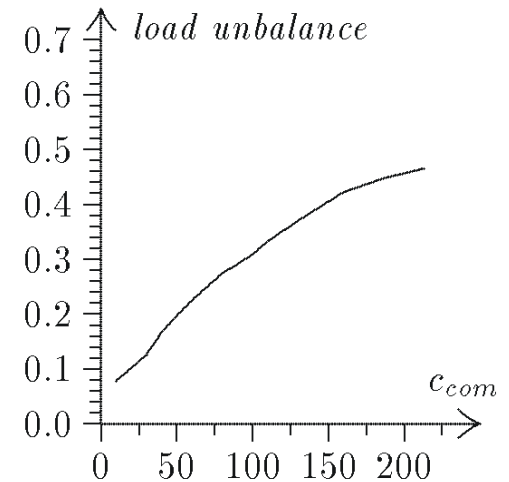
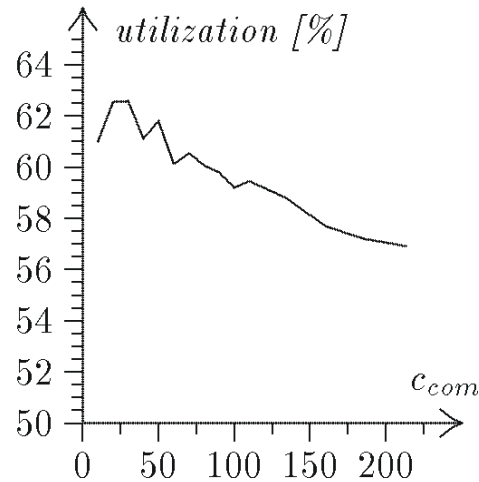
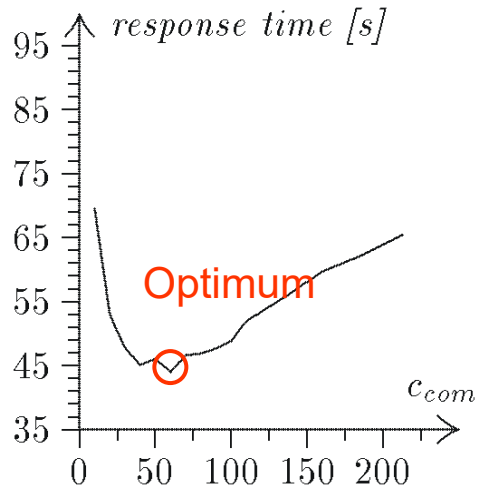

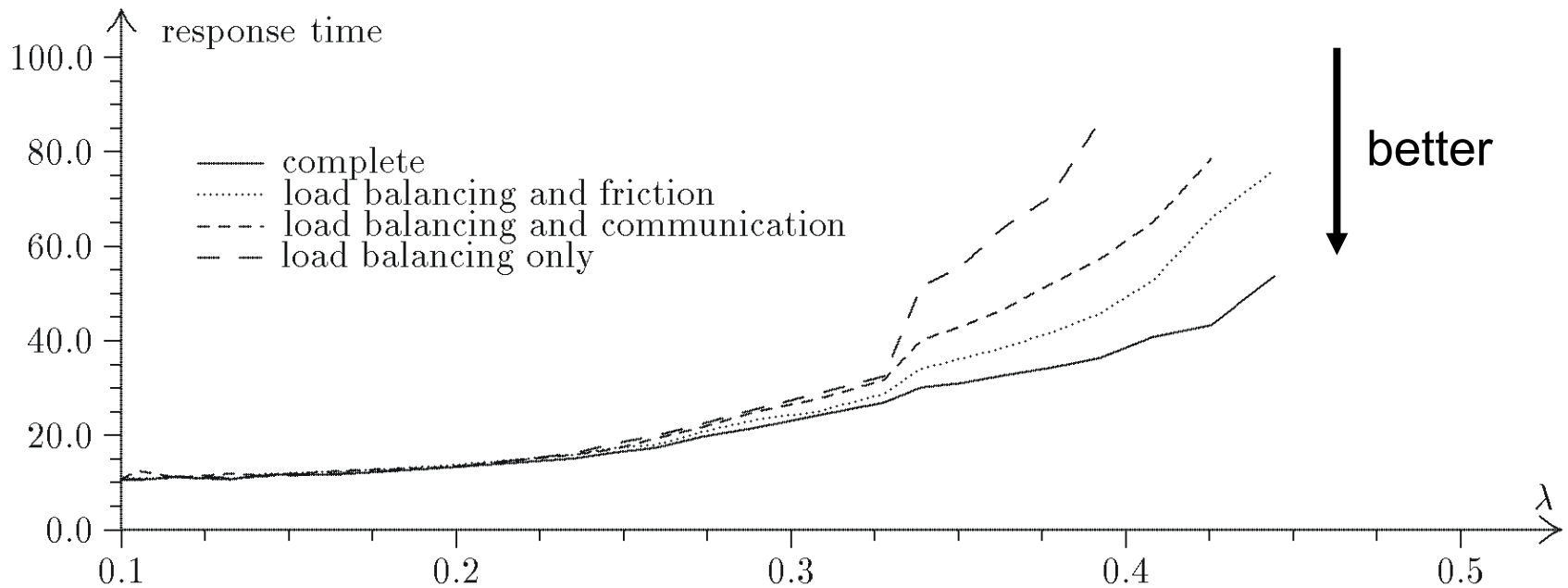

# References

- Barak,A.; Shiloh,A.: *A Distributed Load-balancing Policy for a Multicomputer*. Software - P&E 15,9 (Sept. 1985) pp. 901-913
- Casavant, T.L.; Kuhl,J.G. *A Taxonomy of Scheduling in General-Purpose Distributed Computing Systems*. IEEE TOSE 14,2 (Feb. 1988) pp. 141-154
- Cybenko,G.: *Dynamic Load Balancing for Distributed Memory Multiprocessors*. JPDC 7 (1989) : pp. 279-301
- Ferguson,D.; Yemini,Y.; Nikolaou,C.: *Microeconomic Algorithms for Load Balancing*. Proc. 8th Int. Conf. on Distr. Comp. Syst. San Jose (1988) pp.491-499
- Heiss, H.-U.; Schmitz, M.: *Decentralized Dynamic Load Balancing: The Particles Approach*. Information Sciences, Vol. 84, Issue 1-2 (May 1995) pp. 115 - 128.
- Hinz,D.Y.: *A run-time load balancing strategy for highly parallel systems*. Acta Informatica 29,1 (Feb. 1992) pp.63-94
- Lin,F.C.H.; Keller,R.M.: *The Gradient Model Load Balancing Method*. IEEE TOSE 13,1 (January 1987) pp.32-38
- Cesar A. F. De Rose, Hans-Ulrich Heiss, and Philippe O. A. Navaux. [Distributed Processor Allocation in Multicomputers.](#) In *IEEE Intl. Conference on Cluster Computing (CLUSTER'2000)*, 2000, Chemnitz, Germany, pages 397--398, 2000.
- Tanner, A.: *Distributed Resource Management with Monetary Incentives*. Dissertation, Technische Universität Berlin, August 2005.